



CATALOGUE

Ed.4.0





PRESSCONTROL EVO 04

Water cooled inverter

PRESSCONTROL WALL 08

Wall mounted inverter

PRESSCONTROL BOARD 12

On board inverter

PRESSCONTROL BOARD POOL 14

On board inverter for swimming pool pumps

PRESSCONTROL TWIN 16

Wall mounted inverter for booster sets

MINIPANEL 18

Wall mounted panel for booster sets

MINIPANEL SEWAGE 20

Wall mounted panel for
waste water lifting stations

PRESSCONTROL 22

Pressure flow switch

MASCONTROL 24

Pressure flow switch with 1"1/4 connections

MASCONTROL 3PHASE 26

Three-phase pressure flow switch
with 1"1/4 connections



CONTROLPRES 28

Pressure flow switch
with adjustable working pressure

CONTROLPRES 3PHASE 30

Three-phase pressure flow switch
with adjustable working pressure

MONDIALPRESS 32

Compact pressure flow switch

PRESSFLOW 34

Flowswitch

SERIE BOOSTER KIT 36

Panel for Duty/Stand-by booster sets

GSM CONTROL 38

GSM panel for data transmission

PUMPSTOP 40

Electronic protection for motor

ACCESSORIES 42

* Trevitech si riserva il diritto di apportare modifiche senza obbligo di preavviso.



PRESSCONTROL EVO

Made in Italy

WATER COOLED INVERTER

Varies the number of motor revolutions of the pump depending on the withdrawal from the system in order to maintain constant pressure and flow.

Allows to adjust the pressure of the system and the restart of the pump.

Stops the pump in case of water shortage and protects it from dry running.

Equipped with automatic reset in case of failure and anti-jamming function.

Ensures energy saving.

Can be mounted on surface pumps and submersible pumps.

No need for an expansion tank, check valve, filter and fittings.

Maintenance free.

CONTROL PANEL



Setting up and starting Evo series devices is simple and intuitive.

Thanks to the 4 displays, the operating parameters of the system are clearly visible and easy to consult.

INSTALLATION AND START-UP

Install the device vertically directly on the pump or between the pump and the first use.

Make electrical connections, give power and set the operating parameters.

Press On button to start.

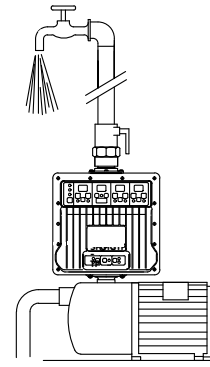

AUTOMATIC RESTARTS

In case of stopping due to a water shortage, the devices will automatically make 10 double attempts to rearm over the 24 hours following the failure, each lasting approximately 5 seconds to allow the pump and the system to reload if possible.

The user can try to rearm the devices at any time by pressing the Restart button.

ANTI-JAMMING FUNCTION

If for any reason the pump remains idle for 24 hours, the unit starts the motor for about 5 seconds.

BOOSTER SETS

Each model of Evo series in the "COM" version is standardly equipped with communication interface and cable to make booster sets.

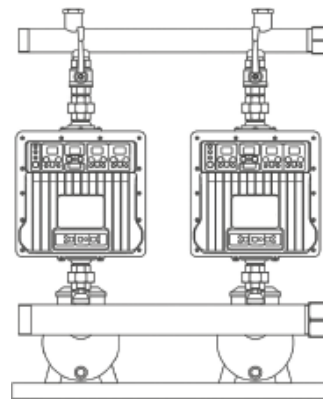

INSTALLATION AND START-UP

Connect the devices to each other via the serial port. Select the Master device and the Slave devices via the communication panel.

OPERATION

The Master device controls the Slave devices and manages the operation of the booster set.

Initially, the pump on which the Master device is installed will start first, but if the demand for water is such that this pump is unable to maintain the set system pressure value, then the second pump on which the Slave device is installed will automatically start. Every time the pumps stop, it will be the second, third and/or fourth pump etc. to start first, depending on how many pumps are installed, to return to the Master device and so on.

PUMPS ALTERNATION DURING CONTINUOUS OPERATION

If for any reason one or more pumps are working continuously, in order to guarantee uniform wear of the pumps, every sixty minutes of continuous operation of a pump, a forced exchange will be made with another pump on stand-by.

The changeover respects the alternating sequence of all the devices.

VARIABLE MASTER

In case of malfunctioning of the Master device, the system will transfer the operation to the Slave device immediately following the Master. If the original Master device has been reset, it will automatically be reintegrated into the system.

AUTOMATIC RESTARTS E ANTI-JAMMING FUNCTION

For details refer to the paragraph above.

OPTIONALS

- Alarm panel.

TECHNICAL FEATURES

	SINGLE-PHASE / SINGLE-PHASE			
	MODELS	MM 8,5	MM 11	MM 13
Mains voltage		1 ~ 230 Vac	1 ~ 230 Vac	1 ~ 230 Vac
Acceptable voltage fluctuations		+/- 15%	+/- 15%	+/- 15%
Frequency (automatic recognition)		50 / 60 Hz	50 / 60 Hz	50 / 60 Hz
Pump motor voltage		1 ~ 230 V	1 ~ 230 V	1 ~ 230 V
Maximum pump motor current		8,5 A	11 A	13 A
Maximum pump motor power		1,1 kW - 1,5 HP	1,5 kW - 2 HP	2,2 kW - 3 HP
Motor soft start		Yes	Yes	Yes
Electrical connection cable to mains H07 RN-F		3Gx1,5 mm ² L 1,5 m schuko plug		
Electrical connection cable to motor H07 RN-F		3Gx1,5 mm ² L 1,5 m		
Length motor cable up to 80 m.		Yes	Yes	Yes
Maximum operating pressure		16 bar	16 bar	16 bar
Adjustable system pressure		2 ÷ 12 bar	2 ÷ 12 bar	2 ÷ 12 bar
Adjustable cut-in pressure		1 ÷ 11 bar	1 ÷ 11 bar	1 ÷ 11 bar
Minimum flow		~ 1 l/min	~ 1 l/min	~ 1 l/min
Maximum operating temperature		60 °C	60 °C	60 °C
Protection degree		IP 65	IP 65	IP 65
Digital manometer		Yes	Yes	Yes
Digital ammeter		Yes	Yes	Yes
Dry running protection		Yes	Yes	Yes
Timed automatic rearming		Yes	Yes	Yes
Anti-jamming function		Yes	Yes	Yes
Protection fuse		Yes	Yes	Yes
Short-circuit protection between phases		Yes	Yes	Yes
Short-circuit protection between phases and earth		Yes	Yes	Yes
Over-current protection		Yes	Yes	Yes
Voltage surge protection		Yes	Yes	Yes
Over-temperature protection		Yes	Yes	Yes
Pressure sensor fault detection		Yes	Yes	Yes
Float switch and level probe connections		Yes	Yes	Yes
Remote ON/OFF connection predisposition		Yes	Yes	Yes
Remote alarm connection predisposition		Yes	Yes	Yes
Accumulation		Integrated	Integrated	Integrated
Check valve		Integrated	Integrated	Integrated
Water discharge		Yes	Yes	Yes
Male connections		1" - 1"	1" 1/4 - 1" 1/4	1" 1/4 - 1" 1/4
Interchangeable male connections		1" 1/4 - 1" 1/4	1" 1/2 - 1" 1/2	1" 1/2 - 1" 1/2
Stainless steel screws		Yes	Yes	Yes
Overall dimensions (L x H x W) and weight		260 x 312 x 285 mm ~ 5 Kg		

- Communication between devices: for each model is available the "COM" version that is standardly equipped with interface and communication cable.



Made in Italy 

PRESSCONTROL WALL / WALL PRO

WALL MOUNTED INVERTER

- The M version can control single-phase pumps or 230V three-phase pumps.
- Can be wall-mounted or installed directly on the pipe system (M and T series).
- Varies the number of motor revolutions of the pump depending to the water withdrawal from the system in order to maintain constant pressure and flow rate.
- Allows to regulate the system pressure and the restart pump pressure.
- Stops the pump in case of water shortage and protects it from dry running.
- Equipped with automatic restart in case of failure and anti-jamming function.
- Ensures energy saving.
- Can be installed on surface and submersible pumps.
- Standardly supplied with stainless steel pressure sensor.

CONTROL PANEL

Setting up and starting the Presscontrol Wall is easy and intuitive thanks to the large and bright LCD display that shows the information and the keyboard that allows to quickly enter and change the operating parameters of the pump.



To save energy, the display turns off one minute after the last operation. To turn the display back on, simply press any button on the keypad.

The LEDs indicating the main phases of the device's operation remain always lit to allow the user to always have the status of the system under control.

Data transmission with NFC technology.

Download our APP Trevitech from Google play or App store and place the mobile phone near the icon NFC to transfer the information from the inverter to your smartphone.



INSTALLATION AND START-UP

Install the device on the wall or directly on the system pipe.

Connect the supplied pressure sensor, make electrical connections and energize.

Provide the use of an expansion tank sized to the hydraulic characteristics of the system.

Follow the instructions on the screen of the device to start the pump.

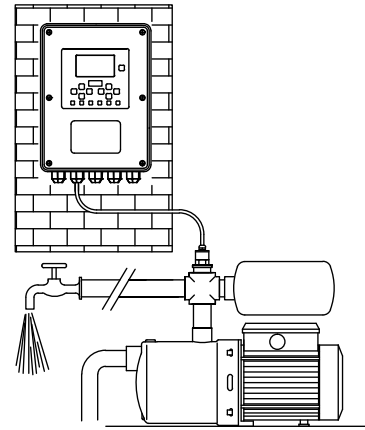

OPERATING MODE

The Presscontrol Wall has three selectable operating modes:

RESIDENTIAL

Standard operation. Ideal for domestic installations pressure booster sets.

IRRIGATION

Allows to set 3 different operating and restart pressures of the pump. Ideal for residential, public irrigation and agriculture.

SWIMMING POOL/INDUSTRY

Allows to set up to 3 different fixed pump operating speeds. Ideal for residential, public swimming pools and industry.

AUTOMATIC RESTARTS

In case of stopping due to a water shortage, the device will automatically make 10 double attempts to rearm over the 24 hours following the failure, each lasting approximately 5 seconds to allow the pump and the system to reload if possible. The user can try to rearm the device at any time by pressing the Restart button.

ANTI-JAMMING FUNCTION

If for any reason the pump remains idle for 24 consecutive hours, the device will start the pump for about 5 seconds.

BOOSTER SETS

INSTALLATION AND START-UP

Connect the devices together using the serial ports.

Program the device selected as Master and the slaves following the instructions on the display.

OPERATION

Connect the devices together using the serial ports.

Program the device selected as Master and the slaves following the instructions on the display.

- **Duty/Assist** The pumps alternate at each start and work simultaneously when needed.
- **Duty/Stand-by** The pumps alternate at each start but never work at the same time.
- **Only pump 1 or 2** Only the pump selected by the user works.

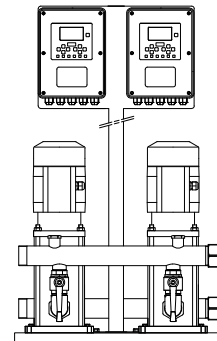

PUMPS ALTERNATION DURING CONTINUOUS OPERATION

If for any reason one or more pumps are working continuously, in order to guarantee uniform wear of the pumps, every sixty minutes of continuous operation of a pump, a forced exchange will be made with another pump on stand-by.

The changeover respects the alternating sequence of all the devices.

VARIABLE MASTER

In case of malfunctioning of the Master device, the system will transfer the operation to the Slave device immediately following the Master. If the original Master device has been reset, it will automatically be reintegrated into the system.

AUTOMATIC RESTARTS E ANTI-JAMMING FUNCTION

For details refer to the paragraph above.

OPTIONALS

- Alarm panel.

TECHNICAL FEATURES

PRESSCONTROL WALL

MODELS	SINGLE-PHASE /		THREE-PHASE /	
	SINGLE-PHASE	THREE-PHASE		
	M 8,5	M 11	M 13	T 6
Mains voltage	1 ~ 230 Vac	1 ~ 230 Vac	1 ~ 230 Vac	3 ~ 400 Vac
Acceptable voltage fluctuations	+/- 15%	+/- 15%	+/- 15%	+/- 15%
Frequency [automatic recognition]	50 / 60 Hz	50 / 60 Hz	50 / 60 Hz	50 / 60 Hz
Single-phase pump motor	1 ~ 230 V	1 ~ 230 V	1 ~ 230 V	-
Three-phase pump motor	3 ~ 230 V Δ	3 ~ 230 V Δ	3 ~ 230 V Δ	3 ~ 400 V Y
Maximum pump motor current	8,5 A	11 A	13 A	6 A
Maximum single-phase pump motor power	1,1 kW - 1,5 HP	1,5 kW - 2 HP	2,2 kW - 3 HP	-
Maximum three-phase pump motor power	1,9 kW - 2,5 HP	2,2 kW - 3 HP	3 kW - 4 HP	2,2 kW - 3 HP
Motor soft start	Yes	Yes	Yes	Yes
Motor cable length up to 80 m	Yes	Yes	Yes	Yes
Maximum operating pressure	25 bar	25 bar	25 bar	25 bar
Adjustable system pressure	2 ÷ 25 bar	2 ÷ 25 bar	2 ÷ 25 bar	2 ÷ 25 bar
Adjustable restart pressure	1 ÷ 24 bar	1 ÷ 24 bar	1 ÷ 24 bar	1 ÷ 24 bar
Adjustable minimum flow	Yes	Yes	Yes	Yes
Maximum operating temperature	50 °C	50 °C	50 °C	50 °C
Protection degree*	IP65	IP65	IP65	IP65
Digital manometer	Yes	Yes	Yes	Yes
Digital ammeter	Yes	Yes	Yes	Yes
Dry running protection	Yes	Yes	Yes	Yes
Automatic restart	Yes	Yes	Yes	Yes
Anti-jamming function	Yes	Yes	Yes	Yes
Protection fuse	Yes	Yes	Yes	Yes
Irrigation mode [double pressure]	Yes	Yes	Yes	Yes
Pool/Industry mode [fixed speed]	Yes	Yes	Yes	Yes
Short-circuit protection between phases	Yes	Yes	Yes	Yes
Short-circuit protection between phases and earth	Yes	Yes	Yes	Yes
Amperometric protection	Yes	Yes	Yes	Yes
Voltage surge protection	Yes	Yes	Yes	Yes
Over-temperature protection	Yes	Yes	Yes	Yes
Pressure sensor fault detection	Yes	Yes	Yes	Yes
Flow switch connection	Yes	Yes	Yes	Yes
BMS protocol connection	Yes	Yes	Yes	Yes
Integrated NFC data transfer system	Yes	Yes	Yes	Yes
Connection for float switch and level probe	Yes	Yes	Yes	Yes
Remote ON/OFF connection	Yes	Yes	Yes	Yes
Remote "Pump on" connection	Yes	Yes	Yes	Yes
Remote alarm connection	Yes	Yes	Yes	Yes
Communication between devices	Yes	Yes	Yes	Yes
Overall dimensions [L x H x W] and weight	200 x 275 x 125 - 8 kg			200 x 275 x 125 - 8 kg

* Device protection degree IP65, cooling fan IP20.

- Note: The minimum and maximum values of the system pressure and the restart pressure vary according to the pressure sensor used.

- Three-phase 230V versions with power up to 27 Ampere are available on request.

PRESSCONTROL WALL PRO

THREE-PHASE

THREE-PHASE / THREE-PHASE

T 9	T 12	T 16	T 19	T 23	T 27
3 ~ 400 Vac	3 ~ 400 Vac	3 ~ 400 Vac	3 ~ 400 Vac	3 ~ 400 Vac	3 ~ 400 Vac
+/- 15%	+/- 15%	+/- 15%	+/- 15%	+/- 15%	+/- 15%
50 / 60 Hz	50 / 60 Hz	50 / 60 Hz	50 / 60 Hz	50 / 60 Hz	50 / 60 Hz
-	-	-	-	-	-
3 ~ 400 V Y	3 ~ 400 V Y	3 ~ 400 V Y	3 ~ 400 V Y	3 ~ 400 V Y	3 ~ 400 V Y
9 A	12 A	16 A	19 A	23 A	27 A
-	-	-	-	-	-
3 kW - 4 HP	5,5 kW - 7,5 HP	7,5 kW - 10 HP	9,2 kW - 12,5 HP	11 kW - 15 HP	15 kW - 20 HP
Yes	Yes	Yes	Yes	Yes	Yes
Yes	Yes	Yes	Yes	Yes	Yes
25 bar	25 bar	25 bar	25 bar	25 bar	25 bar
2 ÷ 25 bar	2 ÷ 25 bar	2 ÷ 25 bar	2 ÷ 25 bar	2 ÷ 25 bar	2 ÷ 25 bar
1 ÷ 24 bar	1 ÷ 24 bar	1 ÷ 24 bar	1 ÷ 24 bar	1 ÷ 24 bar	1 ÷ 24 bar
Yes	Yes	Yes	Yes	Yes	Yes
50 °C	50 °C	50 °C	50 °C	50 °C	50 °C
IP65	IP65	IP65	IP65	IP65	IP65
Yes	Yes	Yes	Yes	Yes	Yes
Yes	Yes	Yes	Yes	Yes	Yes
Yes	Yes	Yes	Yes	Yes	Yes
Yes	Yes	Yes	Yes	Yes	Yes
Yes	Yes	Yes	Yes	Yes	Yes
Yes	Yes	Yes	Yes	Yes	Yes
Yes	Yes	Yes	Yes	Yes	Yes
Yes	Yes	Yes	Yes	Yes	Yes
Yes	Yes	Yes	Yes	Yes	Yes
Yes	Yes	Yes	Yes	Yes	Yes
Yes	Yes	Yes	Yes	Yes	Yes
Yes	Yes	Yes	Yes	Yes	Yes
Yes	Yes	Yes	Yes	Yes	Yes
Yes	Yes	Yes	Yes	Yes	Yes
Yes	Yes	Yes	Yes	Yes	Yes
Yes	Yes	Yes	Yes	Yes	Yes
Yes	Yes	Yes	Yes	Yes	Yes
Yes	Yes	Yes	Yes	Yes	Yes
Yes	Yes	Yes	Yes	Yes	Yes
Yes	Yes	Yes	Yes	Yes	Yes
Yes	Yes	Yes	Yes	Yes	Yes
Yes	Yes	Yes	Yes	Yes	Yes
Yes	Yes	Yes	Yes	Yes	Yes
Yes	Yes	Yes	Yes	Yes	Yes
	270 x 470 x 180 - 12 kg				

A 16 bar steel sensor is supplied as standard.



PRESSCONTROL BOARD

Made in Italy



ON BOARD INVERTER

Varies the number of motor revolutions of the pump depending to the water withdrawal from the system in order to maintain constant pressure and flow rate.

Allows you to adjust the system pressure and the restart pump pressure.

Stops the pump in case of water shortage and protects it from dry running.

Equipped with automatic reset in case of failure and anti-jamming function.

Ensures energy saving.

Standarily supplied with stainless steel pressure sensor.

TECHNICAL FEATURES

	M11	T6
Mains voltage	<u>230 Vac</u>	<u>400 Vac</u>
Acceptable voltage fluctuation	<u>+/- 10%</u>	<u>+/- 10%</u>
Frequency	<u>50/60 Hz</u>	<u>50/60 Hz</u>
Current max	<u>11 A</u>	<u>6 A</u>
Power max	<u>2,2 kW - 3 HP (3~ 230 V)</u>	<u>2,2 kW - 3 HP</u>
Protection degree	<u>IP 55</u>	<u>IP 55</u>
Operating temperature max	<u>60 °C</u>	<u>60 °C</u>
Overall dimensions	<u>172x238x108 mm - 2,5 Kg</u>	<u>172x238x108 mm - 2,5 Kg</u>

CONTROL PANEL

Setting up and starting the device is easy and intuitive thanks to the large and bright color LCD display that shows all the information, and the keyboard that allows you to quickly enter and change the operating parameters of the pump.



To save energy, the display turns off one minute after the last operation. To turn the display back on, simply press any button on the keypad.

The LEDs indicating the main phases of the device's operation remain always lit to allow the user to always have the status of the system under control.

INSTALLATION AND START-UP

Install the device directly on the motor.

Connect the supplied pressure sensor, make electrical connections and energize.

Provide the use of an expansion tank sized to the hydraulic characteristics to the system.

Follow the instructions on the screen of the device to start the pump.

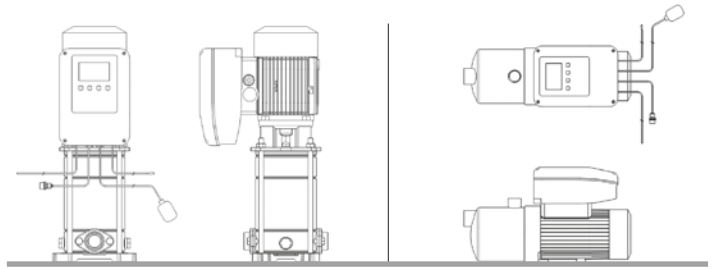

OPERATION

The device starts and stops the pumps depending on the opening and closing of the outlets.

The device can operate in different operating modes:

- RESIDENTIAL** Standard operation. Ideal for domestic installations and booster sets.
- FIX SPEED** Allows to set up a fix speed operation of the pump.
- RWS (Rain Water System)** Allows to drive the RWS valve to change from rain water to mains supply.

AUTOMATIC RESTARTS

In case of stopping due to a water shortage, the device will automatically make 10 double attempts to rearm over the 24 hours following the failure, each lasting approximately 5 seconds to allow the pump and the system to reload if possible.

The user can try to rearm the device at any time by pressing the Restart button.

ANTI-JAMMING FUNCTION

If for any reason the pump remains idle for 24 consecutive hours, the device will start the pump for about 5 seconds.

BOOSTER SETS

INSTALLATION AND START-UP

Connect the devices together using the serial ports.

Program the device selected as Master and the slaves following the instructions on the display.

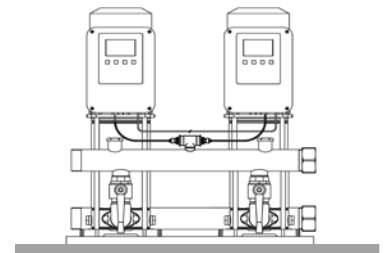

OPERATION

The device starts and stops the pumps according to the opening and closing of the outlets.

It is possible to operate the device in different operating modes:

- **Duty/Assist** The pumps alternate at each start and work simultaneously when needed.
- **Duty/Stand-by** The pumps alternate at each start but never work at the same time.
- **Only pump 1 or 2** Only the pump selected by the user works.

PUMPS ALTERNATION DURING CONTINUOUS OPERATION

If for any reason one or more pumps are working continuously, in order to guarantee uniform wear of the pumps, every sixty minutes of continuous operation of a pump, a forced exchange will be made with another pump on stand-by.

The changeover respects the alternating sequence of all the devices.

VARIABLE MASTER

In case of malfunctioning of the Master device, the system will transfer the operation to the Slave device immediately following the Master. If the original Master device has been reset, it will automatically be reintegrated into the system.

AUTOMATIC RESTARTS AND ANTI-JAMMING FUNCTION

For details refer to the paragraph above.

OPTIONALS

- MODBUS - Connection for external remote communication module.
- BLUETOOTH - Connection for Bluetooth module.
- SND SENSOR - Operating with temperature or pressure differential.
- WALL FIX - Wall mounting bracket.
- Alarm panel.



Made in Italy



PRESSCONTROL BOARD POOL

ON BOARD INVERTER FOR SWIMMING POOL PUMPS

- Equipped with daily and weekly timers.
- Allows manual operating speed selection.
- Allows the management of auxiliary systems.
- Equipped with backwash function.
- Guarantees energy savings.

TECHNICAL FEATURES

	M11	T6
Mains voltage	230 Vac	400 Vac
Acceptable voltage fluctuation	+/- 10%	+/- 10%
Frequency	50/60 Hz	50/60 Hz
Current max	11 A	6 A
Power max	2,2 kW - 3 HP [3~ 230 V]	2,2 kW - 3 HP
Protection degree	IP 55	IP 55
Operating temperature max	60 °C	60 °C
Overall dimensions	172x238x108 mm - 2,5 Kg	172x238x108 mm -2,5 Kg

CONTROL PANEL

Setting up and starting the device is easy and intuitive thanks to the large and bright color LCD display that shows all the information, and the keyboard that allows to quickly enter and change the operating parameters of the pump.



To save energy, the display turns off one minute after the last operation. To turn the display back on, simply press any button on the keypad.

The LEDs indicating the main phases of the device's operation remain always lit to allow the user to always have the status of the system under control.

INSTALLATION AND START-UP

Install the device directly on the motor.

Connect auxiliary systems if needed.

Energize the device, set the timer and working speeds.

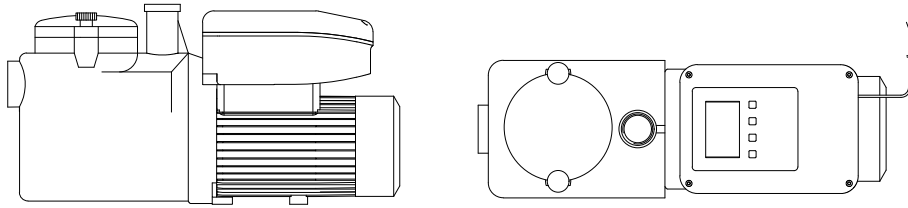

OPERATION

The device can operate in different operating modes:

- **TIMER** Standard operation, the device works according to set times and speeds.
The Time function allows to select two types of clock:
 - WEEKLY** - It allows to set up to 4 working time frames, each with its own operating speed.
 - DAILY** - Allows to set for each day of the week up to 4 working time frames, each with its own working speed.
- **MANUAL** Allows to set up to 4 working speeds that can be manually selected via a button.
- **BACKWASH** Enable this function only when cleaning the filters. The device makes the pump work at maximum speed and disables auxiliary contacts.

AUXILIARY CONTACTS

It is possible to enable up to 4 auxiliary contacts and set their operating times according to the WEEKLY or DAILY logic. This function allows to manage the start-up and shutdown at the desired times of the following systems:

- Saline Chlorine generator
- PH dosing pump
- Pool lights
- Other equipment

There is also a contact to signal pump failure.

OPTIONALS

- MODBUS - Connection for external remote communication module.
- BLUETOOTH - Connection for Bluetooth module.
- WALL FIX - Wall mounting bracket.
- Alarm panel.



Made in Italy



PRESSCONTROL TWIN

WALL MOUNTED INVERTER FOR BOOSTER SETS

Equipped with 2 inverters each dedicated to a single pump of the booster set.

Varies the number of motor revolutions of the pumps depending to the water withdrawal from the system in order to maintain constant pressure and flow rate.

Allows to regulate the system pressure and the restart pump pressure.

Stops the pumps in case of water shortage and protects them from dry running.

Equipped with automatic restart in case of failure and anti-jamming function.

Ensures energy saving.

Standardly supplied with stainless steel pressure sensor.

TECHNICAL FEATURES

	TWIN M11	TWIN T6
Mains voltage	230 Vac	400 Vac
Acceptable voltage fluctuation	+/- 10%	+/- 10%
Frequency	50/60 Hz	50/60 Hz
Current max	11 A	6 A
Power max for each pump single-phase	1,5 kW - 2 HP	---
Power max for each pump three-phase	1,5 kW - 2 HP (3 ~ 230 V Δ)	2,2 kW - 3 HP
Protection degree	IP 65	IP 65
Operating temperature max	60 °C	60 °C
Overall dimensions	200x175x125 mm - 8 Kg.	200x175x125 mm - 8 Kg.

CONTROL PANEL



The device is equipped with latest generation Touch Screen display.

Thanks to the larger and higher resolution screen, reading the parameters and managing all the functions of the device are further simplified.

Simply touch the screen to start/stop the pumps or to carry out any further operation.

The display turns off two minutes after the last operation. To turn the display back on, simply touch the display.

INSTALLATION AND START-UP

Install the device directly on the booster set or on the wall.

Connect the supplied pressure sensor, make electrical connections and energize.

Provide the use of an expansion tank sized to the hydraulic characteristics of the system.

Follow the instructions on the screen of the device to start the pump.

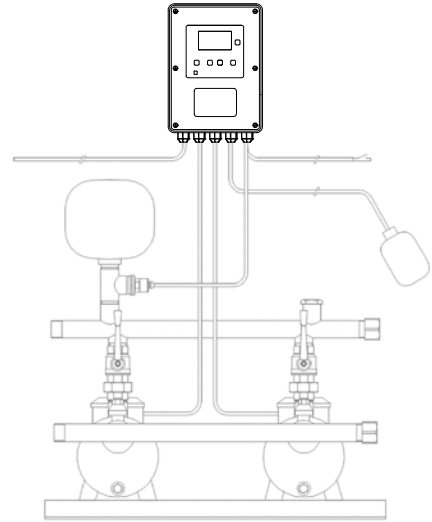

OPERATION

The device starts and stops the pumps depending on the opening and closing of the outlets.

The device can operate in different operating modes:

- **Duty/Assist** The pumps alternate at each start and work simultaneously when needed.
- **Duty/Stand-by** The pumps alternate at each start but never work at the same time.
- **Only pump 1 or 2** Only the pump selected by the user works.

PUMPS ALTERNATION DURING CONTINUOUS OPERATION

If, for any reason, one or more pumps are working continuously, in order to guarantee uniform wear of the pumps, every sixty minutes of continuous operation of a pump a forced exchange will be made with stand-by pump.

The changeover respects the alternating sequence of all the pumps.

AUTOMATIC RESTARTS

If, for any reason, one or more pumps are working continuously, in order to guarantee uniform wear of the pumps, every sixty minutes of continuous operation of a pump a forced exchange will be made with stand-by pump.

The changeover respects the alternating sequence of all the pumps.

ANTI-JAMMING FUNCTION

If for any reason the pump remains idle for 24 consecutive hours, the device will start the pump for about 5 seconds.

VARIABLE MASTER

In case of malfunctioning of the Master device, the system will transfer the operation to the Slave device immediately following the Master. If the original Master device has been reset, it will automatically be reintegrated into the system.

OPTIONALS

- MODBUS - Connection for external remote communication module.
- BLUETOOTH - Connection for Bluetooth module.
- Alarm panel.



Made in Italy



MINIPANEL

WALL MOUNTED PANEL FOR BOOSTER SETS

- Allows to adjust the cut-in and cut-out pressure of the pumps.
- Guarantees the alternation of the pumps at each start.
- Stops the pumps in case of water shortage and protects them from dry running.
- Equipped with automatic reset in case of failure and anti-jamming function.
- Allows the connection of an electric safety float and a remote contact.
- Can also be used to operate a single pump.
- Standarily supplied with stainless steel pressure sensor.

TECHNICAL FEATURES

	Single-phase		Three-phase	
	M2HP	M3HP	T4HP	T5.5HP
Mains voltage	115/230 Vac	115/230 Vac	400 Vac	400 Vac
Acceptable voltage fluctuation	+/- 10%	+/- 10%	+/- 10%	+/- 10%
Frequency	50/60 Hz	50/60 Hz	50/60 Hz	50/60 Hz
Current max	10 A	16 A	8 A	10 A
Power max for each pump at 115V	0,75 kW [1 HP]	1,1 kW [1,5 HP]	----	----
Power max for each pump at 230V	1,5 kW [2 HP]	2,2 kW [3 HP]	----	----
Power max for each pump at 400V	----	----	3 kW [4 HP]	4 kW [5,5 HP]
Protection degree	IP 65	IP 65	IP 65	IP 65
Operating temperature max	60 °C	60 °C	60 °C	60 °C
Overall dimensions	205x170x53 mm - 0,5 Kg	205x170x53 mm - 0,5 Kg	205x170x53 mm - 0,5 Kg	205x170x53 mm - 0,5 Kg

CONTROL PANEL

Setting up and starting the device is easy and intuitive thanks to the large and bright LCD display that shows all the information, and the keyboard that allows you to quickly enter and change the operating parameters of the pump.



To save energy, the display turns off one minute after the last operation. To turn the display back on, simply press any button on the keypad.

The LEDs indicating the main phases of the device's operation remain always lit to allow the user to always have the status of the system under control.

INSTALLATION AND START-UP

Install the device directly on the booster set or on the wall.

Connect the pumps and the supplied ultrasonic sensor to the device.

Energize, set the operating levels and select the desired working mode.

Provide the use of an expansion tank sized to the hydraulic characteristics of the system.

Follow the instructions on the screen of the device to start the pump.

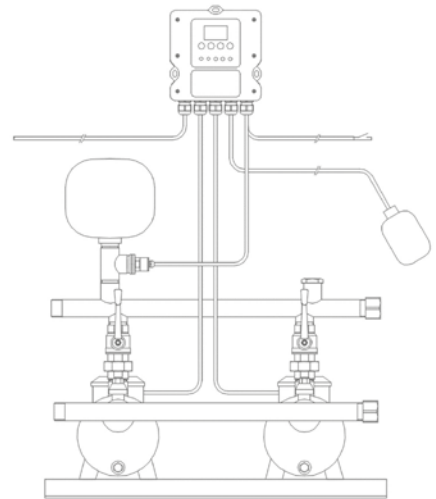

OPERATION

The device starts and stops the pumps depending on the opening and closing of the outlets.

The device can operate in different operating modes:

- **Duty/Assist** The pumps alternate at each start and work simultaneously when needed.
- **Duty/Stand-by** The pumps alternate at each start but never work at the same time.
- **Only pump 1 or 2** Only the pump selected by the user works.

PUMPS ALTERNATION DURING CONTINUOUS OPERATION

If, for any reason, one or more pumps are working continuously, in order to guarantee uniform wear of the pumps, every sixty minutes of continuous operation of a pump a forced exchange will be made with stand-by pump.

The changeover respects the alternating sequence of all the pumps.

AUTOMATIC RESTARTS

In case of stopping due to a water shortage, the device will automatically make 10 double attempts to rearm over the 24 hours following the failure, each lasting approximately 5 seconds to allow the pump and the system to reload if possible.

The user can try to rearm the device at any time by pressing the Restart button.

ANTI-JAMMING FUNCTION

If for any reason the pump remains idle for 24 consecutive hours, the device will start the pump for about 5 seconds.

SPECIAL VERSIONS

- **THERMO** Version equipped with temperature sensor to start the pumps according to set temperatures. Can work for both cooling and heating. Can be integrated with the Timer version.
- **TIMER** Version with programmable weekly clock. Allows to set up to 4 different daily starts for each day of the week.
- **RWS** Version for the management of rainwater collection systems.

OPTIONALS

- Alarm panel.



Made in Italy

MINIPANEL SEWAGE

WALL MOUNTED PANEL FOR WASTE WATER LIFTING STATIONS

- Allows to set the start and stop levels of each pump.
- Guarantees the alternation of the pumps at each start.
- Allows real-time display of the water level.
- Stops the pumps in case of water shortage and protects them from dry running.
- Allows to set the level of alarm intervention.
- Allows the connection of electric emergency float and a remote contact.
- Can also be used to operate a single pump.
- Equipped with ultrasonic sensor set.

TECHNICAL FEATURES

	Single-phase		Three-phase	
	M2HP	M3HP	T4HP	T5.5HP
Mains voltage	115/230 Vac	115/230 Vac	400 Vac	400 Vac
Acceptable voltage fluctuation	+/- 10%	+/- 10%	+/- 10%	+/- 10%
Frequency	50/60 Hz	50/60 Hz	50/60 Hz	50/60 Hz
Current max	10 A	16 A	8 A	10 A
Power max for each pump at 115V	0,75 kW [1 HP]	1,1 kW [1,5 HP]	----	----
Power max for each pump at 230V	1,5 kW [2 HP]	2,2 kW [3 HP]	----	----
Power max for each pump at 400V	----	----	3 kW [4 HP]	4 kW [5,5 HP]
Protection degree	IP 65	IP 65	IP 65	IP 65
Operating temperature max	60 °C	60 °C	60 °C	60 °C
Overall dimensions	205x170x53 mm - 0,5 Kg	205x170x53 mm - 0,5 Kg	205x170x53 mm - 0,5 Kg	205x170x53 mm - 0,5 Kg

CONTROL PANEL

Setting up and starting the device is easy and intuitive thanks to the large and bright LCD display that shows all the information, and the keyboard that allows you to quickly enter and change the operating parameters of the pump.



To save energy, the display turns off one minute after the last operation. To turn the display back on, simply press any button on the keypad.

The LEDs indicating the main phases of the device's operation remain always lit to allow the user to always have the status of the system under control.

INSTALLATION AND START-UP

Install the device near the tank or on the wall.

Connect the pumps and the supplied ultrasonic sensor to the device.

Energize, set the operating levels and select the desired working mode.

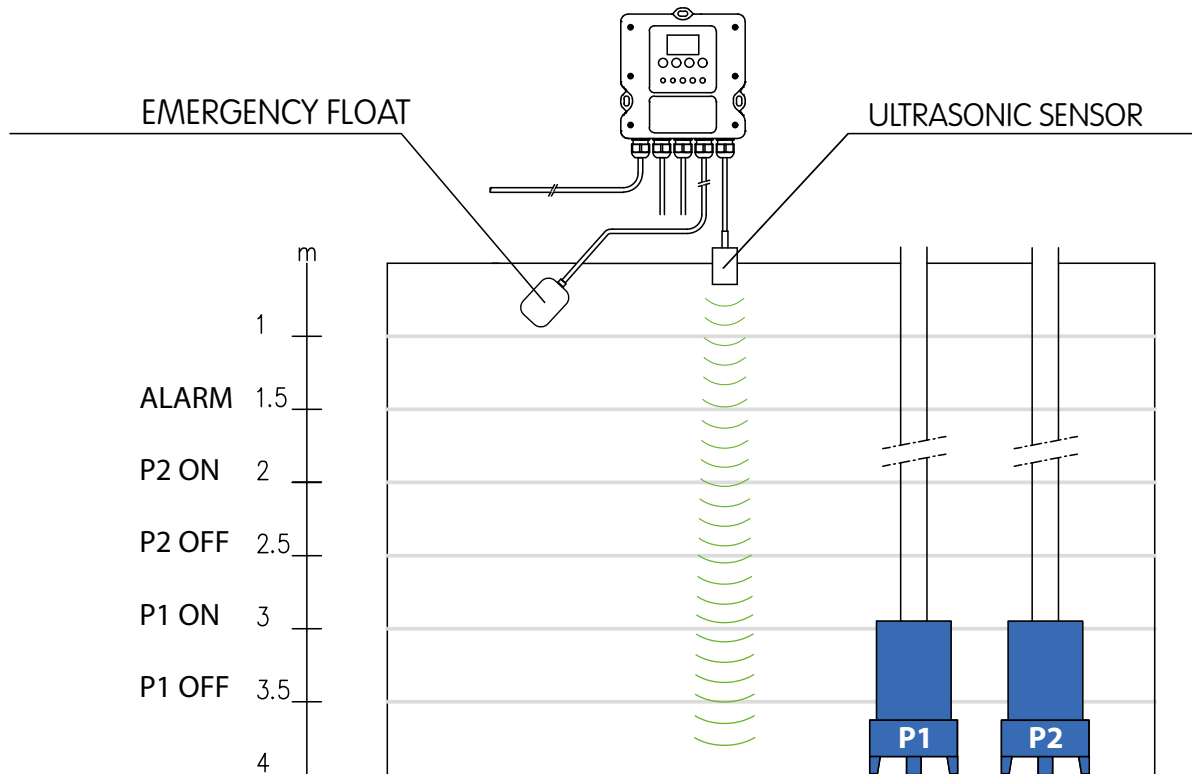

OPERATION

The device starts and stops the pump [or pumps] depending on water level set for each pump.

It is also possible to set the level of alarm intervention.

The device can operate in different operating modes:

- **Duty/Assist** The pumps alternate at each start and work simultaneously when needed.
- **Duty/Stand-by** The pumps alternate at each start but never work at the same time.
- **Only pump 1 or 2** Only the pump selected by the user works.

EMERGENCY FLOAT

In the event that the ultrasonic sensor fails, the water level will activate the emergency float that will start both pumps and signal the alarm.

PUMPS ALTERNATION DURING CONTINUOUS OPERATION

If, for any reason, one or more pumps are working continuously, in order to guarantee uniform wear of the pumps, every sixty minutes of continuous operation of a pump a forced exchange will be made with stand-by pump.

The changeover respects the alternating sequence of all the pumps.

ANTI-JAMMING FUNCTION

If for any reason the pump remains idle for 24 consecutive hours, the device will start the pump for about 5 seconds.

OPTIONALS

- Alarm panel.



Made in Italy

PRESSCONTROL

PRESSURE FLOW SWITCH

Starts and stops the pump depending on opening and closing of the outlets.

Stops the pump in case of water shortage and protects it from dry running.

Can be installed on surface and submersible pumps.

No need for an expansion tank, check valve, filter or fittings.





Maintenance free.

TECHNICAL FEATURES

	PRESSCONTROL	PRESSCONTROL R	PRESSCONTROL UP	PRESSCONTROL UP R
Single-phase mains voltage	230 Vac	230 Vac	115/230 Vac	115/230 Vac
Acceptable voltage fluctuation	+/- 10%	+/- 10%	+/- 10%	+/- 10%
Frequency	50/60 Hz	50/60 Hz	50/60 Hz	50/60 Hz
Current max	10 A	10 A	10 A	10 A
Power max at 115V	—	—	0,75 kW [1 HP]	0,75 kW [1 HP]
Power max at 230V	1,5 kW [2 HP]	1,5 kW [2 HP]	1,5 kW [2 HP]	1,5 kW [2 HP]
Protection degree	IP 65	IP 65	IP 65	IP 65
Operating pressure max	12 bar	12 bar	12 bar	12 bar
Operating temperature max	65 °C	65 °C	65 °C	65 °C
Minimum flow	~1 l/min	~1 l/min	~1 l/min	~1 l/min
Male connections	Gc 1"	Gc 1"	Gc 1"	Gc 1"

CONTROL PANEL

SIGNALING OF THE WORKING PHASES AND ANOMALIES

	POWER ON	Green led on	Device energized
	PUMP ON	Yellow led on	Pump running
	FAILURE	Red led on	Water shortage
	RESTART	Button	Reset after failure

INSTALLATION AND START-UP

The device can be installed directly on the pump or between the pump and the first tap.

Make all the electrical connections and energize.

From now on, the device will turn the pump on and off depending on the opening and closing of the tap.

In case of a temporary blackout, the device will automatically rearm once the electricity returns.

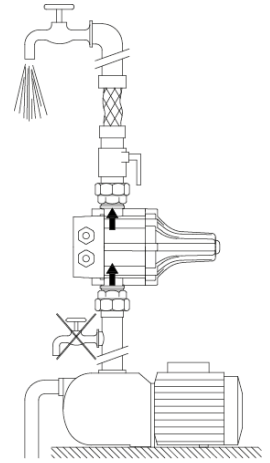

SELECTION OF THE DEVICE WITH THE CORRECT RESTART VALUE

Refer to the following table to choose the device with the correct restart value suitable to the characteristics of the system. Standard restart value is 1,5 bar. On request, restart values different from the standard are available as indicated in the table.

RESTART PRESSURE	1,2 bar	1,5 bar	2,2 bar	3 bar	4 bar
FLOORS NUMBER	4	5	7	10	13
BUILDING HEIGHT (H)	12 mt	15 mt	22 mt	30 mt	40 mt
MAX PUMP PRESSURE	min 2,5 bar	min 3 bar	min 3,5 bar	min 4,5 bar	min 5,5 bar

PRESSCONTROL *UP*

It differs from Presscontrol because it can be powered at both 115 Vac and 230 Vac and is equipped with automatic reset and anti-jamming function.

AUTOMATIC RESTARTS

In case of stopping due to a water shortage, the device will automatically make 10 double attempts to rearm over the 24 hours following the failure, each lasting approximately 5 seconds to allow the pump and the system to reload if possible.

The user can try to rearm the device at any time by pressing the Restart button.

ANTI-JAMMING FUNCTION

If for any reason the pump remains idle for 24 consecutive hours, the device will start the pump for about 5 seconds.

PRESSCONTROL *R*

It differs from the Presscontrol in the hydraulic part, modified to allow the adjustment of the restart value.

The restart adjustment function can also be combined with the Presscontrol UP.

SETTING THE RESTART VALUE

Set the desired restart value by turning the screw on the back of the unit. Turn clockwise to increase restart pressure value and counterclockwise to decrease restart pressure value [see fig. 1.]

For a correct regulation of the restart value, follow the table below.

RESTART PRESSURE	1,5 bar	2 bar	2,5 bar	3 bar
FLOORS NUMBER	5	6	8	10
BUILDING HEIGHT (H)	15 mt	20 mt	25 mt	30 mt
MAX PUMP PRESSURE	min 3 bar	min 3,5 bar	min 4 bar	min 4,5 bar



FIG.1

OPTIONALS

- GasOil version - suitable for use with petroleum and other chemicals.
- AdBlue version - suitable for use with AdBlue.



Made in Italy

MASCONTROL

PRESSURE FLOW SWITCH WITH 1"1/4 CONNECTIONS

- Can be energized with either 115 Vac or 230 Vac.
- Starts and stops the pump depending on opening and closing of the outlets.
- It has 1"1/4 male connections to guarantee a higher flow rate.
- Stops the pump in case of water shortage and protects it from dry running.
- Equipped with automatic restarts in case of failure and anti-jamming function.
- No need for an expansion tank, check valve, filter or fittings.
- Can be installed on surface and submersible pumps up to 3 HP.
- Maintenance free.

TECHNICAL FEATURES

	MASCONTROL	MASCONTROL R	MASCONTROL 24V
Single-phase mains voltage	115/230 Vac	115/230 Vac	24 Vcc
Acceptable voltage fluctuation	+/- 10%	+/- 10%	+/- 10%
Frequency	50/60 Hz	50/60 Hz	50/60 Hz
Current max	16 A	16 A	20 A
Power max at 115V	1,1 kW [1,5 HP]	1,1 kW [1,5 HP]	—
Power max at 230V	2,2 kW [3 HP]	2,2 kW [3 HP]	—
Power max at 24V	—	—	0,37 kW [0,5 HP]
Protection degree	IP 65	IP 65	IP 65
Operating pressure max	12 bar	12 bar	12 bar
Operating temperature max	60 °C	60 °C	60 °C
Minimum flow	~1 l/min	~1 l/min	~1 l/min
Male connections	Gc 1"1/4	Gc 1"1/4	Gc 1"1/4

CONTROL PANEL

SIGNALING OF THE WORKING PHASES AND ANOMALIES

	POWER ON	Green led on	Device energized
	PUMP ON	Yellow led on	Pump running
	FAILURE	Red led blinking	Water shortage
	RESTART	Button	Reset after failure

INSTALLATION AND START-UP

The device can be installed directly on the pump or between the pump and the first tap.

Make all the electrical connections and energize.

From now on, the device will turn the pump on and off depending on the opening and closing of the tap.

In case of a temporary blackout, the device will automatically rearm once the electricity returns.

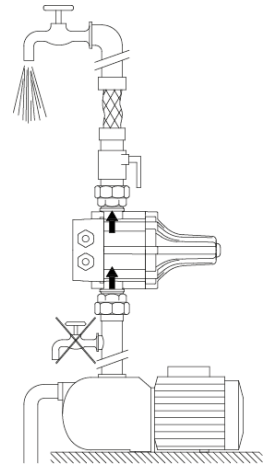

SELECTION OF THE DEVICE WITH THE CORRECT RESTART VALUE

Refer to the following table to choose the device with the correct restart value suitable to the characteristics of the system. Standard restart value is 1,5 bar. On request, restart values different from the standard are available as indicated in the table.

RESTART PRESSURE	1,2 bar	1,5 bar	2,2 bar	3 bar	4 bar
FLOORS NUMBER	4	5	7	10	13
BUILDING HEIGHT (H)	12 mt	15 mt	22 mt	30 mt	40 mt
MAX PUMP PRESSURE	min 2,5 bar	min 3 bar	min 3,5 bar	min 4,5 bar	min 5,5 bar

AUTOMATIC RESTARTS

In case of stopping due to a water shortage, the device will automatically make 10 double attempts to rearm over the 24 hours following the failure, each lasting approximately 5 seconds to allow the pump and the system to reload if possible.

The user can try to rearm the device at any time by pressing the Restart button.

ANTI-JAMMING FUNCTION

If for any reason the pump remains idle for 24 consecutive hours, the device will start the pump for about 5 seconds.

MASCONTROL *R*

It differs from MASCONTROL in the hydraulic part, modified to allow the adjustment of the restart value and for the presence, as standard, of the pressure gauge.

SETTING THE RESTART VALUE

Set the desired restart value by turning the screw on the back of the unit. Turn clockwise to increase restart pressure value and counterclockwise to decrease restart pressure value [see fig. 1].

For a correct regulation of the restart value, follow the table below.

RESTART PRESSURE	1,5 bar	2 bar	2,5 bar	3 bar
FLOORS NUMBER	5	6	8	10
BUILDING HEIGHT (H)	15 mt	20 mt	25 mt	30 mt
MAX PUMP PRESSURE	min 3 bar	min 3,5 bar	min 4 bar	min 4,5 bar



FIG.1

MASCONTROL *24V*

24 Vdc version - ideal for use on campers, industrial vehicles, boats, photovoltaic systems, etc.

OPTIONALS

- GasOil version - suitable for use with petroleum and other chemicals.
- 12 Vdc version.



Made in Italy

 PATENTED

MASCONTROL 3PHASE

THREE-PHASE PRESSURE FLOW SWITCH WITH 1"1/4 CONNECTIONS

Three-phase power supply 400 Vac.

Starts and stops the pump depending on opening and closing of the outlets.

It has 1"1/4 male connections to guarantee a higher flow rate.

Stops the pump in case of water shortage and protects it from dry running.

Equipped with automatic restart in case of failure and anti-jamming function.

No need for an expansion tank, check valve, filter or fittings.

Can be installed on surface and submersible pumps up to 3 HP.





Maintenance free.

TECHNICAL FEATURES

	MASCONTROL 3PHASE	MASCONTROL 3PHASE UP
Three-phase mains voltage	400 Vac	230 Vac / 400 Vac
Three-phase pump motor voltage	400 V Y	230 V Δ / 400 V Y
Acceptable voltage fluctuation	+/- 10%	+/- 10%
Frequency	50/60 Hz	50/60 Hz
Current max	6 A	6 A
Power max at 230V	—	1,1 kW [1,5 HP]
Power max at 400V	2,2 kW [3 HP]	2,2 kW [3 HP]
Protection degree	IP 65	IP 65
Operating pressure max	12 bar	12 bar
Operating temperature max	50 °C	50 °C
Minimum flow	~1 l/min	~1 l/min
Male connections	Gc 1"1/4	Gc 1"1/4
Standard equipped cables	H07RN-F 4G x 1,5 mm ²	H07RN-F 4G x 1,5 mm ²

CONTROL PANEL

SIGNALING OF THE WORKING PHASES AND ANOMALIES

	POWER ON	Green led on	Device energized
	PUMP ON	Yellow led on	Pump running
	FAILURE	Red led blinking	Water shortage
	RESTART	Button	Reset after failure

INSTALLATION AND START-UP

The device can be installed directly on the pump or between the pump and the first tap.

Make all the electrical connections and energize.

From now on, the device will turn the pump on and off depending on the opening and closing of the tap.

In case of a temporary blackout, the device will automatically rearm once the electricity returns.

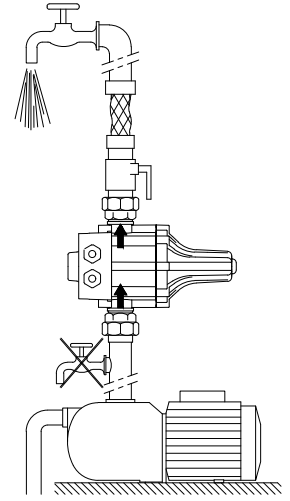

SELECTION OF THE DEVICE WITH THE CORRECT RESTART VALUE

Refer to the following table to choose the device with the correct restart value suitable to the characteristics of the system. Standard restart value is 1,5 bar. On request, restart values different from the standard are available as indicated in the table.

RESTART PRESSURE	1,2 bar	1,5 bar	2,2 bar	3 bar	4 bar
FLOORS NUMBER	4	5	7	10	13
BUILDING HEIGHT (H)	12 mt	15 mt	22 mt	30 mt	40 mt
MAX PUMP PRESSURE	min 2,5 bar	min 3 bar	min 3,5 bar	min 4,5 bar	min 5,5 bar

AUTOMATIC RESTARTS

In case of stopping due to a water shortage, the device will automatically make 10 double attempts to rearm over the 24 hours following the failure, each lasting approximately 5 seconds to allow the pump and the system to reload if possible.

The user can try to rearm the device at any time by pressing the Restart button.

ANTI-JAMMING FUNCTION

If for any reason the pump remains idle for 24 consecutive hours, the device will start the pump for about 5 seconds.

MASCONTROL **3PHASE UP**

It differs from MASCONTROL 3PHASE for the presence of electrical protections for the motor.

It can be powered with either 230 or 400 V three-phase voltage.

PROTECTION AGAINST INVERSION OF THE DIRECTION OF ROTATION OF THE MOTOR

In case of accidental inversion of a phase in power supply, the device detects the anomaly and automatically maintains the correct direction of rotation of the motor as set and verified during installation.

PROTECTION AGAINST A MISSING PHASE IN POWER SUPPLY

In the event of a missing phase in power supply, the device detects the fault and prevents the pump from starting.

OPTIONALS

- Pressure gauge.
- GasOil version - suitable for use with petroleum and other chemicals.



Made in Italy

CONTROLPRES

PRESSURE FLOW SWITCH WITH ADJUSTABLE WORKING PRESSURE





- Can be energized with either 115 Vac or 230 Vac.
- Starts and stops the pump depending on opening and closing of the outlets.
- Allows to reduce the maximum pressure of the pump and to set the working pressure.
- Stops the pump in case of water shortage and protects it from dry running.
- Equipped with automatic restart in case of failure and anti-jamming function.
- No need for an expansion tank, check valve, filter or fittings.
- Can be installed on surface and submersible pumps up to 3 HP.
- Maintenance free.

TECHNICAL FEATURES

	CONTROLPRES
Single-phase mains voltage	115/230 Vac
Acceptable voltage fluctuation	+/- 10%
Frequency	50/60 Hz
Current max	16 A
Power max at 115V	1,1 kW [1,5 HP]
Power max at 230V	2,2 kW [3 HP]
Protection degree	IP 65
Operating pressure max	12 bar
Operating temperature max	60 °C
Minimum flow	~1 l/min
Pressure regulating range	3 - 6,5 bar
Male connections	Gc 1"1/4

CONTROL PANEL

SIGNALING OF THE WORKING PHASES AND ANOMALIES

	POWER ON	Green led on	Device energized
	PUMP ON	Yellow led on	Pump running
	FAILURE	Red led blinking	Water shortage
	RESTART	Button	Reset after failure

INSTALLATION AND START-UP

The device can be installed directly on the pump or between the pump and the first tap.

Make all the electrical connections and energize.

From now on, the device will turn the pump on and off depending on the opening and closing of the tap.

In case of a temporary blackout, the device will automatically rearm once the electricity returns.

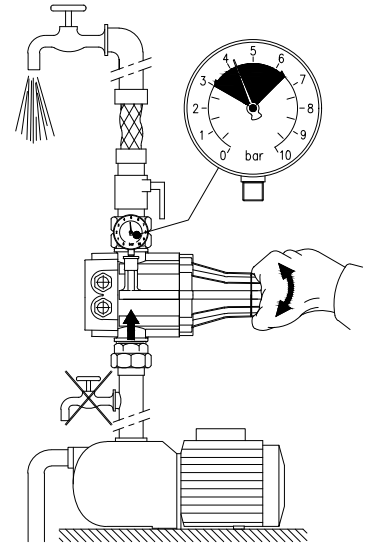

REGULATION OF THE WORKING PRESSURE

To set the pressure to the desired value, turn the knob on the rear of the device clockwise to increase the pressure and counterclockwise to decrease it [adjustment range from 3 to 6,5 bar]. The restart value is directly proportional to the regulated pressure [see table].

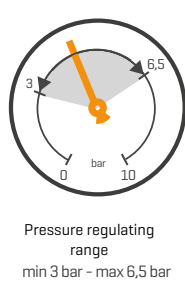
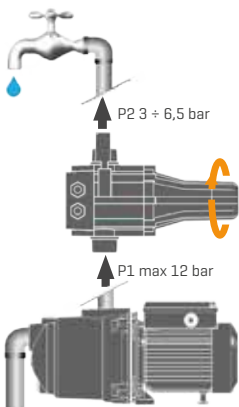

SET PRESSURE	3 bar	3,5 bar	4 bar	4,5 bar	5 bar	5,5 bar	6 bar	6,5 bar
RESTART PRESSURE	1,2 bar	1,5 bar	2 bar	2,5 bar	3 bar	3,5 bar	4 bar	4,5 bar
FLOORS NUMBER	4	5	6	8	10	11	13	15
BUILDING HEIGHT (H)	12 mt	15 mt	20 mt	25 mt	30 mt	35 mt	40 mt	45 mt
MAX PUMP PRESSURE	min 4,5 bar	min 5 bar	min 5,5 bar	min 6 bar	min 6,5 bar	min 7 bar	min 7,5 bar	min 8 bar

AUTOMATIC RESTARTS

In case of stopping due to a water shortage, the device will automatically make 10 double attempts to rearm over the 24 hours following the failure, each lasting approximately 5 seconds to allow the pump and the system to reload if possible.

The user can try to rearm the device at any time by pressing the Restart button.

ANTI-JAMMING FUNCTION

If for any reason the pump remains idle for 24 consecutive hours, the device will start the pump for about 5 seconds.



Made in Italy

PATENTED

CONTROLPRES 3PHASE

THREE-PHASE PRESSURE FLOW SWITCH WITH ADJUSTABLE WORKING PRESSURE

Three-phase power supply 400 Vac.

Starts and stops the pump depending on opening and closing of the outlets.

Allows to reduce the maximum pressure of the pump and to set the working pressure.

It has 1 1/4" male connections to guarantee a higher flow rate.

Stops the pump in case of water shortage and protects it from dry running.

Equipped with automatic restart in case of failure and anti-jamming function.

No need for an expansion tank, check valve, filter or fittings.

Can be installed on surface and submersible pumps up to 3 HP.

Maintenance free.





TECHNICAL FEATURES

	CONTROLPRES 3PHASE
Three-phase mains voltage	400 Vac
Three-phase pump motor voltage	400 V Y
Acceptable voltage fluctuation	+/- 10%
Frequency	50/60 Hz
Current max	6 A
Power max at 230V	—
Power max at 400V	2,2 kW [3 HP]
Protection degree	IP 65
Operating pressure max	12 bar
Operating temperature max	50 °C
Minimum flow	-1 l/min
Pressure regulating range	3 - 6,5 bar
Male connections	Gc 1 1/4"
Standard equipped cables	H07RN-F 4G x 1,5 mm ²

	CONTROLPRES 3PHASE UP
Three-phase mains voltage	230 Vac / 400 Vac
Three-phase pump motor voltage	230 V Δ / 400 V Y
Acceptable voltage fluctuation	+/- 10%
Frequency	50/60 Hz
Current max	6 A
Power max at 230V	1,1 kW [1,5 HP]
Power max at 400V	2,2 kW [3 HP]
Protection degree	IP 65
Operating pressure max	12 bar
Operating temperature max	50 °C
Minimum flow	-1 l/min
Pressure regulating range	3 - 6,5 bar
Male connections	Gc 1 1/4"
Standard equipped cables	H07RN-F 4G x 1,5 mm ²

CONTROL PANEL

SIGNALING OF THE WORKING PHASES AND ANOMALIES

	POWER ON	Green led on	Device energized
	PUMP ON	Yellow led on	Pump running
	FAILURE	Red led blinking	Water shortage
	RESTART	Button	Reset after failure

INSTALLATION AND START-UP

The device can be installed directly on the pump or between the pump and the first tap.

Make all the electrical connections and energize.

From now on, the device will turn the pump on and off depending on the opening and closing of the tap.

In case of a temporary blackout, the device will automatically rearm once the electricity returns.

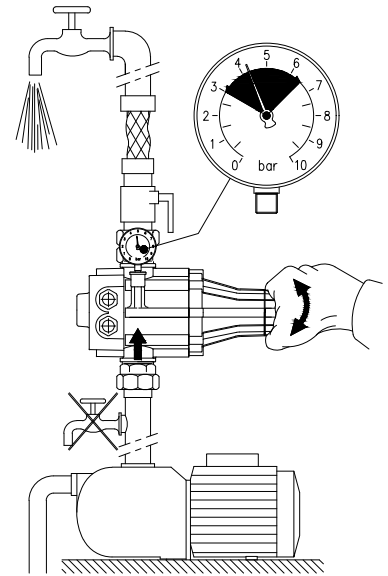

REGULATION OF THE WORKING PRESSURE

To set the pressure to the desired value, turn the knob on the rear of the device clockwise to increase the pressure and counterclockwise to decrease it [adjustment range from 3 to 6,5 bar]. The restart value is directly proportional to the regulated pressure [see table].

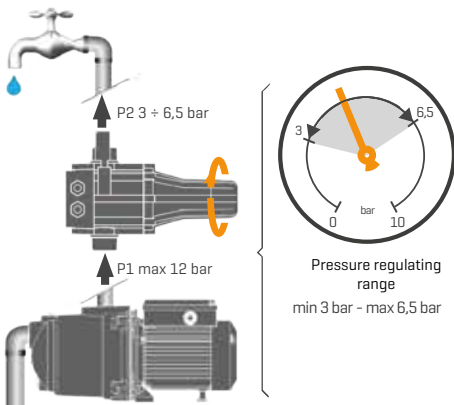

SET PRESSURE	3 bar	3,5 bar	4 bar	4,5 bar	5 bar	5,5 bar	6 bar	6,5 bar
RESTART PRESSURE	1,2 bar	1,5 bar	2 bar	2,5 bar	3 bar	3,5 bar	4 bar	4,5 bar
FLOORS NUMBER	4	5	6	8	10	11	13	15
BUILDING HEIGHT (H)	12 mt	15 mt	20 mt	25 mt	30 mt	35 mt	40 mt	4,5 mt
MAX PUMP PRESSURE	min 4,5 bar	min 5 bar	min 5,5 bar	min 6 bar	min 6,5 bar	min 7 bar	min 7,5 bar	min 8 bar

AUTOMATIC RESTARTS

In case of stopping due to a water shortage, the device will automatically make 10 double attempts to rearm over the 24 hours following the failure, each lasting approximately 5 seconds to allow the pump and the system to reload if possible.

The user can try to rearm the device at any time by pressing the Restart button.

ANTI-JAMMING FUNCTION

If for any reason the pump remains idle for 24 consecutive hours, the device will start the pump for about 5 seconds.

CONTROLPRES 3PHASE UP

It differs from CONTROLPRES 3PHASE for the presence of electrical protections for the motor.

It can be powered with either 230 or 400 V three-phase voltage.

PROTECTION AGAINST INVERSION OF THE DIRECTION OF ROTATION OF THE MOTOR

In case of accidental inversion of a phase in power supply, the device detects the anomaly and automatically maintains the correct direction of rotation of the motor as set and verified during installation.

PROTECTION AGAINST A MISSING PHASE IN POWER SUPPLY

In the event of a missing phase in power supply, the device detects the fault and prevents the pump from starting.



Made in Italy

MONDIALPRESS

COMPACT PRESSURE FLOW SWITCH

Starts and stops the pump depending on opening and closing of the outlets.

Stops the pump in case of water shortage and protects it from dry running.

Can be installed on surface and submersible pumps.

No need for an expansion tank, check valve, filter or fittings.

Maintenance free.

TECHNICAL FEATURES

	MONDIALPRESS 2LED	MONDIALPRESS UP	MONDIALPRESS UPT
Single-phase mains voltage	230 Vac	115/230 Vac	115/230 Vac
Acceptable voltage fluctuation	+/- 10%	+/- 10%	+/- 10%
Frequency	50/60 Hz	50/60 Hz	50/60 Hz
Current max	8 A	8 A	8 A
Power max at 115 V	—	0,55 kW [0,75 HP]	0,55 kW [0,75 HP]
Power max at 230 V	1,1 kW [1,5 HP]	1,1 kW [1,5 HP]	1,1 kW [1,5 HP]
Protection degree	IP 65	IP 65	IP 65
Operating pressure max	10 bar	10 bar	10 bar
Operating temperature max	60 °C	60 °C	60 °C
Minimum flow	~1 l/min	~1 l/min	~1 l/min
Male connections	Gc 1"	Gc 1"	Gc 1"

CONTROL PANEL

SIGNALING OF THE WORKING PHASES

	POWER ON	Green led on	Device energized
	PUMP ON	Yellow led on	Pump running
	RESTART	Button	Reset after failure

INSTALLATION AND START-UP

The device can be installed directly on the pump or between the pump and the first tap.

Make all the electrical connections and energize.

From now on, the device will turn the pump on and off depending on the opening and closing of the tap.

In case of a temporary blackout, the device will automatically rearm once the electricity returns.

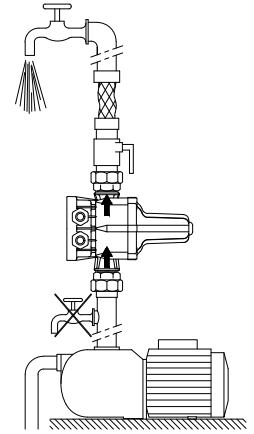

SELECTION OF THE DEVICE WITH THE CORRECT RESTART VALUE

Refer to the following table to choose the device with the correct restart value suitable to the characteristics of the system. Standard restart value is 1,5 bar. On request, restart values different from the standard are available as indicated in the table.

RESTART PRESSURE	0,8 bar	1,2 bar	1,5 bar	2,2 bar	3 bar
FLOORS NUMBER	2	4	5	7	10
BUILDING HEIGHT (H)	8 mt	12 mt	15 mt	22 mt	30 mt
MAX PUMP PRESSURE	min 2 bar	min 2,5 bar	min 3 bar	min 3,5 bar	min 4,5 bar

MONDIALPRESS UP

Mondialpress UP is equipped with the red Failure LED to signal water shortage.

CONTROL PANEL

SIGNALING OF THE WORKING PHASES AND ANOMALIES

	POWER ON	Green led on	Device energized
	PUMP ON	Yellow led on	Pump running
	FAILURE	Red led blinking	Water shortage
	RESTART	Button	Reset after failure



MONDIALPRESS UP T

Mondialpress UP T is equipped with automatic restarts and anti-jamming function.

Can be energized with either at 115 V or 230 Vac.

AUTOMATIC RESTARTS

In case of stopping due to a water shortage, the devices will automatically make 10 double attempts to rearm over the 24 hours following the failure, each lasting approximately 5 seconds to allow the pump and the system to reload if possible.

The user can try to rearm the devices at any time by pressing the Restart button.

ANTI-JAMMING FUNCTION

If for any reason the pump remains idle for 24 consecutive hours, the device will start the pump for about 5 seconds.



Made in Italy



PRESSFLOW

FLOWSWITCH

Can be energized with either 115 Vac or 230 Vac.

Starts and stops the pump depending on opening and closing of the outlets.

Stops the pump in case of water shortage and protects it from dry running.

Maintenance free.

TECHNICAL FEATURES

	PRESSFLOW	PRESSFLOW <i>UP</i>
Single-phase mains voltage	115/230 Vac	115/230 Vac
Acceptable voltage fluctuation	+/- 10%	+/- 10%
Frequency	50/60 Hz	50/60 Hz
Current max	8 A	8 A
Power max. at 115V	0,55 kW [0,75 HP]	0,55 kW [0,75 HP]
Power max. at 230V	1,1 kW [1,5 HP]	1,1 kW [1,5 HP]
Protection degree	IP 65	IP 65
Operating pressure max	16 bar	16 bar
Operating temperature max	65 °C	65 °C
Minimum flow	~0,5 l/min	~0,5 l/min
Male connections	Gc 1"	Gc 1"

CONTROL PANEL

SIGNALING OF THE WORKING PHASES AND ANOMALIES

	POWER ON	Green led on	Device energized
	PUMP ON	Yellow led on	Pump running
	RESTART	Button	Reset after failure

INSTALLATION AND START-UP

The device can be installed directly on the pump or between the pump and the first tap.

Make all the electrical connections and energize.

In order to operate it requires a minimum flow that passes through it when a tap of the system is opened.

For this reason, the device and the system taps must be installed lower than the tank.

Starts and stops the pump depending on the opening and closing of the taps. In case of a temporary blackout, the device will automatically restart once the electricity returns.

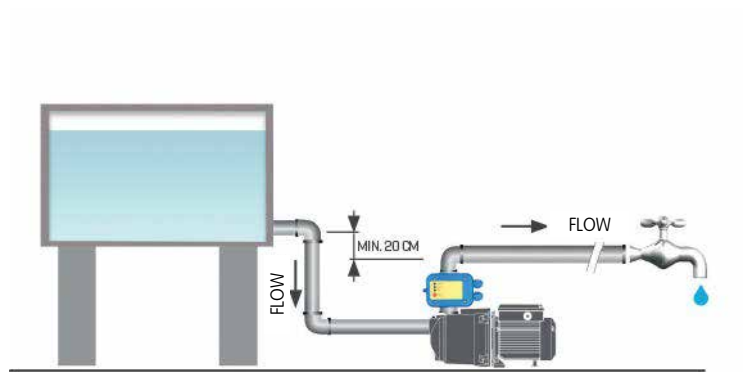
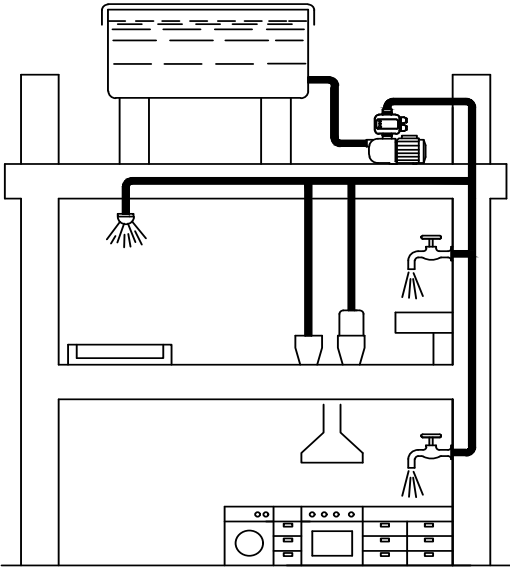

PRESSFLOW UP

The UP version is different from the standard PRESSFLOW due to the presence of automatic restarts and the anti-jamming function. The device automatically starts the pump for about 7 seconds every 30 minutes for 6 hours. The first start takes place 30 minutes after the last pump stop.

The device also automatically starts the pump for about 7 seconds every 24 hours (antijamming function). The pump is started 24 hours after the last pump stop.

This model is ideal for the direct provisioning from the water mains in the event of frequent interruptions in the water supply service.

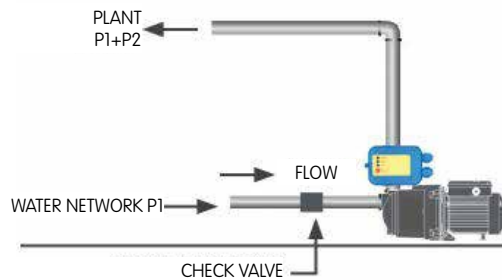



BOOSTER KIT

Made in Italy



PANEL FOR DUTY/STAND-BY BOOSTER SETS

Guarantees the alternation of the pumps at each start.

Allows the connection of electric float for dry running protection.





Available in two versions, for operation with ON/OFF controls or for operation under VFD.

TECHNICAL FEATURES

	ON/OFF Version	VFD Version
Single-phase mains voltage	230 Vac	230 Vac
Acceptable voltage fluctuation	+/- 10%	+/- 10%
Frequency	50/60 Hz	50/60 Hz
Current max	12 A	12 A
Power max for each pump	1,5 kW [2 HP]	1,5 kW [2 HP]
Minimum pwm frequency [with VFD]	—	10 kHz
Protection degree	IP 65	IP 65
Operating temperature max	50 °C	50 °C

CONTROL PANEL

SIGNALING OF THE WORKING PHASES

	POWER ON	Green led on	Device energized
	PUMP 1 ON	Yellow led on	Pump 1 on
	PUMP 2 ON	Yellow led on	Pump 2 on
	FLOAT	Red led blinking	Intervention of safety float switch

INSTALLATION AND START-UP

Install the device as shown in the figure and energize.

At the opening of the outlet, the control system powers the device that starts the first pump.

At each following start-up the device alternates the pumps ensuring uniform wear resulting in a longer life of the booster set.

If the control system is not equipped with dry running protection, an electric float may be installed for protection.

In the event of a power failure, the unit will automatically reset when the power returns.

**BOOSTER KIT
WITH PRESSURE SWITCH**

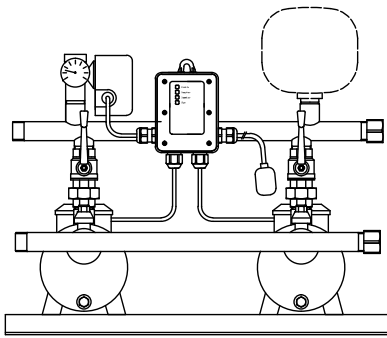

**BOOSTER KIT
WITH VFD**

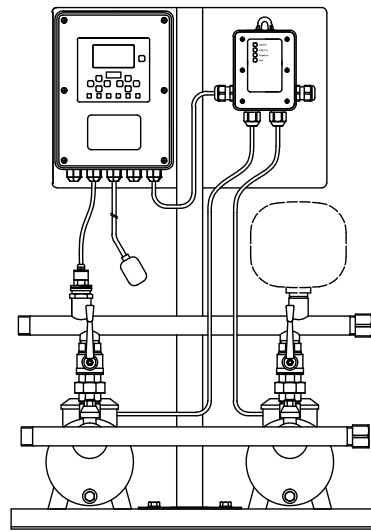

TRANSFER SET

The devices of the Booster kit series, suitably wired, can be used to make transfer booster sets.

Install the device as shown in the figure and energize.

When the water level in the tank drops, the float switch activates the device that starts the first pump.

Once the maximum level of water inside the tank is restored, the float switch disables the device that stops the pump.

At each following start the device alternates the pumps ensuring uniform wear resulting in a longer life of the booster set.

If the suction tank remains without water, the safety float switch will stop the system to protect the pumps from dry running.

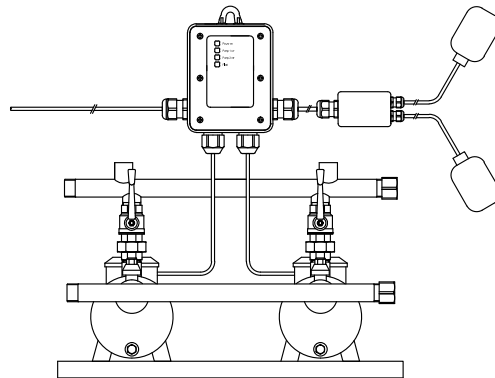



Made in Italy

GSM CONTROL

GSM PANEL FOR DATA TRANSMISSION

GSM device for data reception and transmission.

Equipped with analog and digital inputs and outputs.

Programmable from Smartphone by means of a dedicated App with NFC technology.

Sending/receiving data via SMS.

TECHNICAL FEATURES

	GSM CONTROL
Single-phase mains voltage	230 Vac
Acceptable voltage fluctuation	+/- 10%
Frequency	50/60 Hz
Inputs	N.1 digitale RS486 N.2 analogici
Outputs	N.2 analogiche
Operating temperature max	60 °C

CONTROL PANEL

SIGNALING OF THE WORKING PHASES

	POWER ON	Green led on	Device energized
	COM	Green led on	Communication between devices is active
	NETWORK	Yellow led on	GSM network available
	DATA TRANSFER	Green led on	Data transfer

INSTALLATION AND START-UP

Download the TREVITECH App for programming and reading the operating parameters.

Insert the data SIM into the device.

Energize the device and bring the Smartphone close to the  icon to read the data.

At this point you can program all the operating parameters.

Once all the fields of the App have been filled in, bring the Smartphone closer to the device to program GSM Control.

OPERATION

Compatible with any type of data SIM on the market, it allows to send customized messages up to three phone numbers preset by the user by Smartphone.

Also connected to any commercial appliance (inverter, control panel, etc.) equipped with inputs/outputs analog/digital, through the App allows you to customize the information to send and/ or receive.

EXAMPLE OF INSTALLATION

A typical example of installation is shown in the figure.

If the system to which GSM Control must be connected is located in a room without signal you can move the GSM Control where there is enough signal that the LED Network on the device will be on.





Made in Italy



PUMPSTOP

ELECTRONIC MOTOR SAVER





Stops the pump in case of water shortage and protects it from dry running.
Stops the pump and protects the motor in case of overcurrent.

TECHNICAL FEATURES

	PUMPSTOP	PUMPSTOP <i>UP</i>	PUMPSTOP <i>IP 65</i>	PUMPSTOP <i>IP 65 UP</i>
Single-phase mains voltage	230 Vac	230 Vac	230 Vac	230 Vac
Acceptable voltage fluctuation	+/- 10%	+/- 10%	+/- 10%	+/- 10%
Frequency	50 Hz	50 Hz	50 Hz	50 Hz
Pump motor current	Min 3 A - Max 8 A	Min 6 A - Max 10 A	Min 3 A - Max 8 A	Min 6 A - Max 10 A
Operating temperature	Min 5 °C - Max 45 °C	Min 5 °C - Max 45 °C	Min 5 °C - Max 45 °C	Min 5 °C - Max 45 °C
Ambient temperature	Max 55 °C	Max 55 °C	Max 55 °C	Max 55 °C
Protection degree	---	---	IP 65	IP 65

CONTROL PANEL

SIGNALING OF THE WORKING PHASES AND ANOMALIES

	POWER ON	Green led on	Device energized
	PUMP ON	Yellow led on	Pump running
	FAILURE	Red led	Water shortage Overcurrent
		{ Blinking On	
	RESTART	Button	Motor data acquisition Reset after failure

INSTALLATION

To operate, it must be connected to the power supply line of the pump.

For this reason, the power supply of the pump must be inserted in the device, which is then connected to the power socket.

EXAMPLE OF INSTALLATION

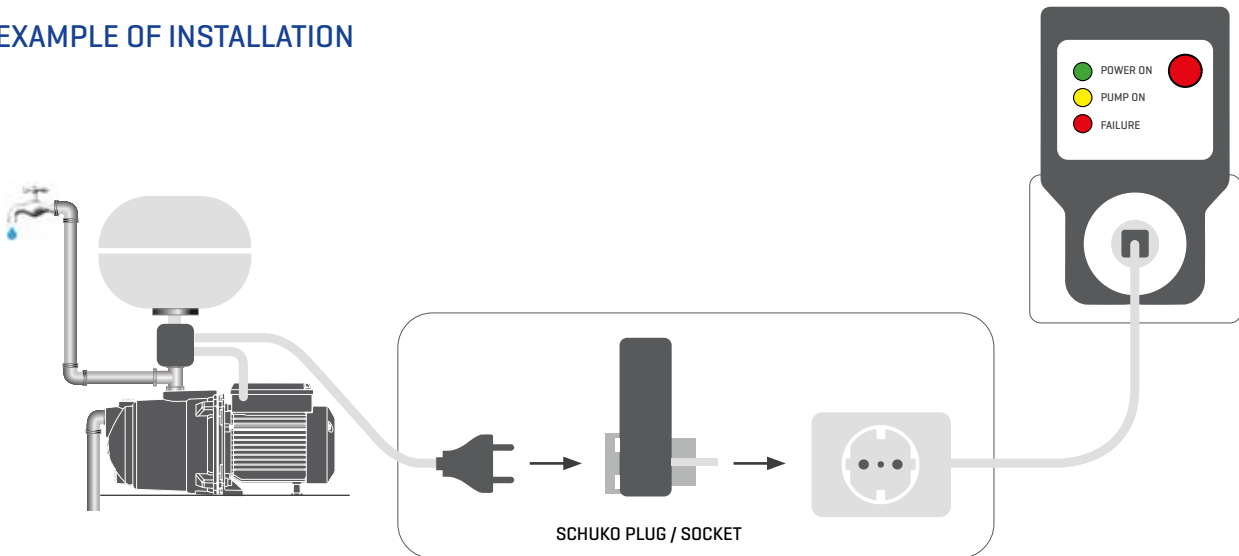

OPERATION

In case of water shortage, the device stops the pump protecting it from dry running. This failure is indicated with the blinking red Failure led.

In case of the current absorption exceeding 8 Ampere (or 10 Ampere for Pumpstop Plus version), the device stops the pump and protects it against over-current. This failure is indicated with the red Failure led on.

To restore normal operation to the device and the system simply press the red Restart button.

In case of a temporary blackout, the device will automatically rearm once the electricity returns.

PUMPSTOP *UP*

This is the enhanced version of the PUMPSTOP.

PUMPSTOP UP can be used on single-phase electric pumps with absorptions between 6 and 10 Ampere.

SPECIAL VERSIONS

- **PUMPSTOP "AUSTRALIA"** Version with Australian plug/socket.
- **ON BOARD PUMPSTOP** The "on-board" version of Logicstop, inserted directly into the terminal box cover of the pump. Made only on request.



ACCESSORIES

ACCESSORIES INDEX

SENSORS	44
INSTANT STOP FLOATERS	45
ELECTRIC FLOATERS	46
PRESSURE SWITCHES AND CONNECTIONS	47
AIR FEEDERS	48
MINI BOOSTER	49
MANIFOLDS FOR BOOSTER SETS	50
STAINLESS STEEL CHECK VALVES	52
BALL CHECK VALVES	53
ALARM PANEL	54

PRESSURE SENSOR

Steel pressure sensor with detachable cable.

TECHNICAL FEATURES

	MODEL		
	T-PS10	T-PS16	T-PS25
Measurement range	0-10 bar	0-16 bar	0-25 bar
Accuracy	+/-0,5 % F.S.		
Output signal	4... 20 mA		
Working temperature	- 20...+85 °C		
Pressure connection	G1/4		
Protection degree	IP 65		
Electrical connection	M12 waterproof outlet		
Material	SS AISI 304		
Cable lenght	1,5 mt		



MODEL	RANGE	CODE	PACKAGE
T-PS10	0-10 bar	RCIV00221	1 pcs.
T-PS16	0-16 bar	RCIV00203	1 pcs.
T-PS25	0-25 bar	RCIV00222	1 pcs.

Nota: Available on request:

- AISI 316
- Different pressure range
- Different power supply
- Temperature sensor

Cable connection



Dimensions mm

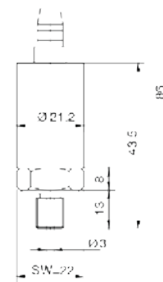

ULTRASONIC SENSOR

Ultrasonic level sensor for collection tanks.

TECHNICAL FEATURES

Measurement range	0,25 mt-4 mt
Accuracy	0.5 F.S.
Output signal	4-20 mA
Working temperature	-10 °C +50 °C
Distanza max	4 mt
Blind zone	25cm
Protection degree	IP68
Reading corner	25°
Cable lenght	4 mt

MODEL	CODE	PACKAGE
T-US2.25	RCMP00101	1 pcs.
T-US4.25	RCMP00102	1 pcs.



Dimensions mm

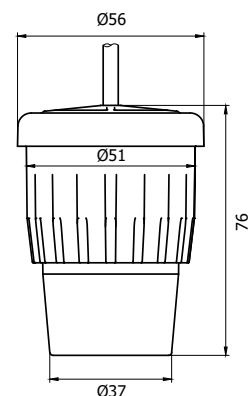

T-FLOAT

FLOAT SWITCH FOR CLEAN WATER

Float switch to use with clean water for the automation of pumps and use in water tanks.



TECHNICAL FEATURES

Microswitch characteristics	20(8)A 250 Vac
Homologations	ENEC/CE - 10(8)A 250 Vac
Operating temperature	0°C ÷ 50°C
Protection degree	IP 68
Switching angle	±45°

Dimensions	81 x 131 x 41,5 mm
Weight	154 gr
Volume	243 cm ³
Pressure resistance	1 bar
Enclosure	Non-toxic polypropylene [PP]

MODEL	CODE	CABLE TYPE	CABLE LENGHT	FUNCTION	COUNTERWEIGHT	PACKAGE
T-FLOAT	PFGA00106	H07RN-F 3X1	1 mt	double	No	60 pcs.
T-FLOAT	PFGACP101	PVC 3X1	1,5 mt	double	Yes	60 pcs.
T-FLOAT	PFGACP102	PVC 3X1	2 mt	double	Yes	60 pcs.
T-FLOAT	PFGACP103	PVC 3X1	3 mt	double	Yes	50 pcs.
T-FLOAT	PFGACP104	PVC 3X1	5 mt	double	Yes	40 pcs.
T-FLOAT	PFGACP105	PVC 3X1	10 mt	double	Yes	20 pcs.

Note: other models and versions available on request.

Made in Italy

T-FLOAT SW

FLOAT SWITCH FOR SEWAGE WATER

Float switch to use in sewage and industrial wastewater with residues of suspended agglomerates and turbulent water.

Made with double watertight chamber and counterweight incorporated in the body.



TECHNICAL FEATURES

Microswitch characteristics	10(3)A 250 Vac
Homologations	ENEC/CE - 10(3)A 250 Vac
Operating temperature	0°C ÷ +50°C
Protection degree	IP 68
Switching angle	±45°

Dimensions	117 x 222 mm (Øxh)
Weight	1100 gr
Volume	1000 cm ³
Pressure resistance	2 bar
Enclosure	Non-toxic polypropylene [PP]

MODEL	CODE	CABLE TYPE	CABLE LENGHT	FUNCTION	PACKAGE
T-FLOAT-SW	PFGACP004	H07RN-F	5 mt	double	15 pcs.
T-FLOAT-SW	PFGACP005	H07RN-F	10 mt	double	10 pcs.
T-FLOAT-SW	PFGACP006	H07RN-F	20 mt	double	7 pcs.

Note: other models and versions available on request.

Made in Italy

FAST-FLOAT

INSTANT STOP FLOAT SWITCH

Constant flow rate until the tank is completely filled.
Faster filling and less noise than traditional systems.
Optimizes fillings and reduces the passage of air (where present) from the water meter to the tank.



TECHNICAL FEATURES

Operating temperature	0°C ÷ 50°C
Overpressure	10 bar
Service	Continuous
Working pressure	0,2-6 bar

Dimensions	240x80x50 mm (mod. 3/8", 1/2") 350x150x70 mm (mod. 3/4" -> 1 1/2")
Weight	350 gr
Enclosure	Non-toxic polycarbonate
Screws	Stainless Steel

MODEL	CODE	MALE CONNECTION	PACKAGE
FAST-FLOAT	PFGA00301	3/8"	25 pcs.
FAST-FLOAT	PFGA00302	1/2"	25 pcs.
FAST-FLOAT	PFGA00303	3/4"	25 pcs.
FAST-FLOAT	PFGA00304	1"	25 pcs.
FAST-FLOAT	PFGA00305	1 1/4"	25 pcs.
FAST-FLOAT	PFGA00306	1 1/2"	25 pcs.

Note: other models and versions available on request.

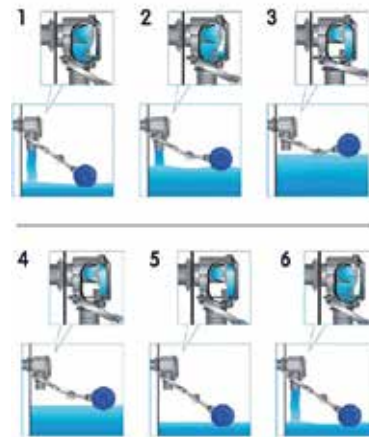

Made in Italy

FAST-FLOAT EVO

ELECTRONIC DEVICE TO MANAGE FILLING AND/OR EMPTYING OF WATER TANKS.

Reduces waterwaste and air passage from the watermeter.
In series, with a booster set reduces pumps starts, extending pumps life and reducing electricity consumption.
It has a high flow rate, making the operations of filling and/or emptying faster.
Does not fear the presence of water impurities and does not require maintenance.



TECHNICAL FEATURES

Single-phase mains voltage	230Vac
Acceptable voltage fluctuations	±10%
Frequency	50/60 Hz
Current max	4 A

Protection degree	IP 65
Working temperature max	60° C
Dimensions	350 gr
Weight	110x190x48 mm

COMPONENTS INCLUDED

MODEL	CODE
FASTTT-FLOAT EVO 1"	PFGA10101
FASTTT-FLOAT EVO 3/4"	PFGA10102

Electrovalve



Double function float



EXAMPLE OF APPLICATION

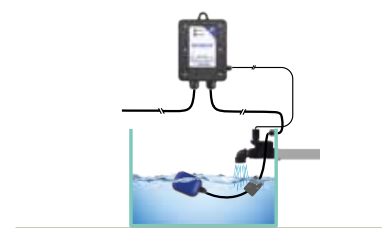

Made in Italy

PRESSURE SWITCH



Swivel female connector

TECHNICAL FEATURES

	MODEL			
	FGS2	FYG22	FYG32	T-PRESS 01
Adjusting range	1,4 - 4,6 bar	2,8 - 7,0 bar	5,6 - 10,5 bar	1,4 - 4,6 bar
Factory calibration	1,4 - 2,8 bar	5,4 - 7,0 bar	8,0 - 10,5 bar	1,4 - 2,8 bar
Female connections	Gc ¼"	Gc ¼"	Gc ¼"	Gc ¼"
Operating temperature max	70° C	70° C	70° C	70° C
Protection degree	IP20	IP20	IP20	IP20
Dimensions mm WxHxD	70,5x99x96	70,5x99x96	70,5x99x96	70,5x99x96

MODEL	CODE	ADJUSTING RANGE	PACKAGE
FGS-2	ST8000103	1,4 - 4,6 bar	25 pcs.
FYG-22	ST8000102	2,8 - 7,0 bar	25 pcs.
FYG-32	ST8000101	5,6 - 10,5 bar	25 pcs.
T-PRESS-01	PFSWC0002	1,4 - 4,6 bar	25 pcs.

QUICK CONNECTOR 1"

Male/female quick connector for quick installation on the pump.



MODEL	CODE	SIZE	PACKAGE
Quick connector 1"	ST7220101	1" gas	10 pcs.

AIR CONTROL

AIR FEEDER

Air feeders guarantee the presence of the air cushion in the pressure tank.

INSTALLATION

Connect the air feeder vertically to the tank and pump intake.

OPERATION

The correct operation of the feeder involves an aspiration of air of about 30 seconds at every pump start.

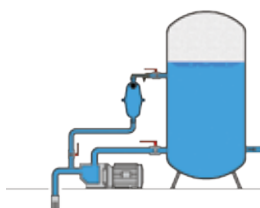

When the system is not running, the feeder is full of water.

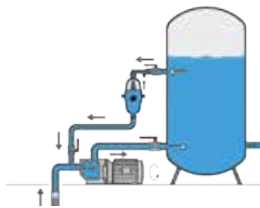

When the pump starts, a depression is created that generates a flow of water from the tank to the pump suction passing through the feeder venturi and generating a flow of air from outside that progressively replaces the water contained in the feeder.

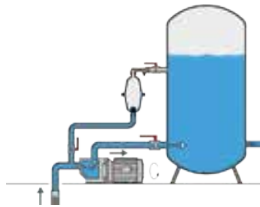

During pump operation, the water level inside the feeder drops until the float switch closes the outlet. The feeder is now filled with air.

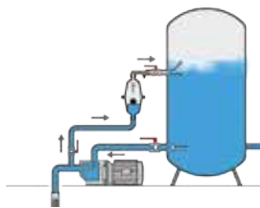

When the pump stops, a flow of water is generated which flows from the tank through the pump and fills the feeder by pushing the contained air into the tank. The feeder is now ready to run the next cycle.

MODEL	CODE	TANK CAPACITY	DIMENSIONS MM			
			H	L	Ø	Gc
AIRCONTROL 500	PFAL00001	100/500	220	126	106	1/2"
AIRCONTROL 2000	PFAL00002	750/2000	275	185	162	3/4"
AIRCONTROL 4000	PFAL00003	2500/4000	405	185	162	3/4"
AIRCONTROL 6000	PFAL00004	4000/6000	535	185	162	3/4"

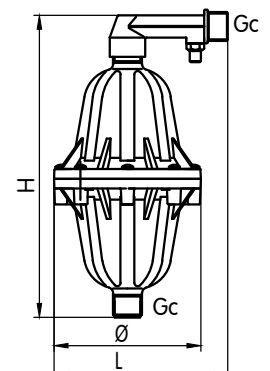

Made in Italy

MINI BOOSTER

SMART DOMESTIC BOOSTING

Starts and stops the pump depending on the opening and closing of the outlets.

Very silent.

Pressure boosting of hot and cold water in residential homes.

Stops automatically in case of water shortage.



TECHNICAL FEATURES

Single-phase mains voltage	230 V	Head max	12 mt	Protection degree	IP 42
Frequency	50 Hz	Flow rate max	3.0 m ³ /h	Insulation Class	F
Current max	1,25 A	Liquid temp.	2 - 95 °C	Schuko plug	1,3 m
Power max	275 W	Male connections	Gc 3/4"	Noise level	45 dB

APPLICATIONS

Roof Booster - See figure 1/A and 1/B

Install the device at the base of the roof tank to create a booster effect every time a tap in the system is open.

City Mains Booster - See figure 2

Install the device directly to the city water mains to create a booster effect every time a tap in the system is open.

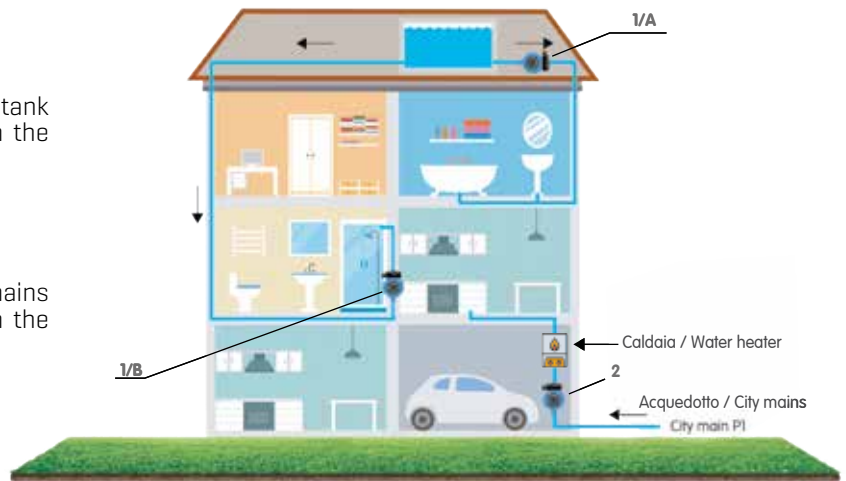

MODE SELECTOR

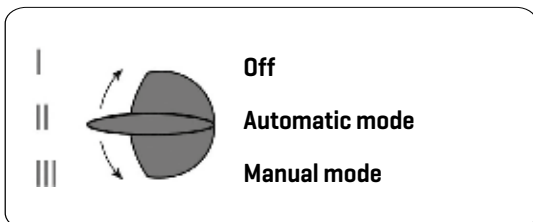

MODEL	CODE	PUMP BODY	SHAFT	IMPELLER
Mini Booster	PFB00S001	Cast iron GG20	Ceramic	PP + GF40

Performance chart at n=2900 r/min

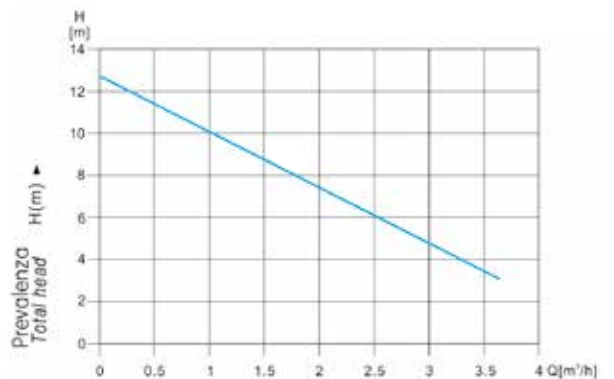

MANIFOLD FOR BOOSTER SETS

TECHNICAL FEATURES

Manufacturing process:	Pipe cold buckling
Material:	Stainless steel Aisi 304 (Aisi 316 on request)
Welded joints:	Made with TIG method without any additional material
Surface treatment:	Degreasing, pickling and electropolishing
Threaded ends:	UNI ISO 228/1 gas cilindric
Nominal working pressure:	16 bar



DELIVERY MANIFOLD FOR 2 PUMPS

MODEL	CODE	DNM	DMP	DIMENSIONS MM						WEIGHT KG
				A	B	C	D	E	F	
T2M 150/100	PFMCOL001	1" 1/2 M	1" M	600	300	150	370	115	90	1,370
T2M 200/100	PFMCOL002	2" M	1" M	600	300	150	370	115	90	1,600
T2M 200/125	PFMCOL003	2" M	1" 1/4 M	600	300	150	370	115	90	1,654
T2M 200/150	PFMCOL004	2" M	1" 1/2 M	600	300	150	370	115	90	1,675
T2M 250/150	PFMCOL005	2" 1/2 M	1" 1/2 M	600	300	150	370	115	90	2,447
T2M 300/150	PFMCOL006	3" M	1" 1/2 M	700	360	170	430	135	115	3,200
T2M 300/200	PFMCOL007	3" M	2" M	600	300	150	370	115	90	3,400
T2M 300/200L	PFMCOL008	3" M	2" M	700	360	170	370	165	90	3,530
T2M 400/250	PFMCOL009	DN100*	2" 1/2 M	760	360	170	430	165	145	6,930

* PN16 Flanges from pressed stainless steel.

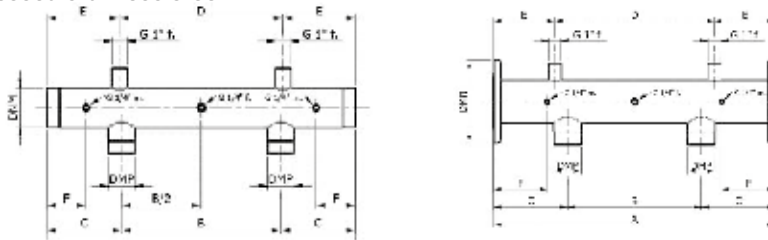

SUCTION MANIFOLD FOR 2 PUMPS

MODEL	CODE	DNM	DMP	DIMENSIONS MM				WEIGHT KG
				A	B	C	D	
T2A 150/100	PFMCOL601	1" 1/2 M	1" M	600	300	150	65	1,205
T2A 200/100	PFMCOL602	2" M	1" M	600	300	150	65	1,441
T2A 200/125	PFMCOL603	2" M	1" 1/4 M	600	300	150	65	1,500
T2A 200/150	PFMCOL604	2" M	1" 1/2 M	600	300	150	65	1,600
T2A 250/125	PFMCOL605	2" 1/2 M	1" 1/2 M	600	300	150	65	2,295
T2A 300/150	PFMCOL606	3" M	1" 1/2 M	700	360	170	65	2,261
T2A 300/200	PFMCOL607	3" M	2" M	600	300	150	65	3,094
T2A 300/200L	PFMCOL608	3" M	2" M	700	360	170	65	3,384
T2A 400/250	PFMCOL609	DN100*	2" 1/2 M	760	360	200	95	6,700

* PN16 Flanges from pressed stainless steel.

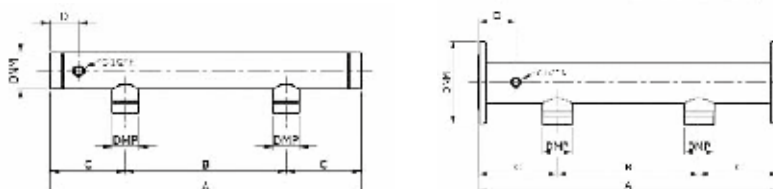

Made in Italy

* On request it is possible to supply custom-made manifolds.

DELIVERY MANIFOLD FOR 3 PUMPS

MODEL	CODE	DNM	DMP	DIMENSIONS MM						WEIGHT KG
				A	B	C	D	E	F	
T3M 200/100	PFMCOL010	2" M	1" M	900	300	150	370	80	90	2,34
T3M 200/125	PFMCOL011	2" M	1" 1/4 M	900	300	150	370	80	90	2,34
T3M 250/125	PFMCOL012	2" 1/2 M	1" 1/4 M	900	300	150	370	80	90	3,62
T3M 250/150	PFMCOL013	2" 1/2 M	1" 1/2 M	900	300	150	370	80	90	3,66
T3M 300/150	PFMCOL014	3" M	1" 1/2 M	900	300	150	370	80	90	4,69
T3M 300/200L	PFMCOL015	3" M	2" M	1060	360	170	370	160	90	5,07
T3M 400/200	PFMCOL016	DN100*	2" 1/2 M	1120	360	200	370	130	120	13,08



* PN16 Flanges from pressed stainless steel.

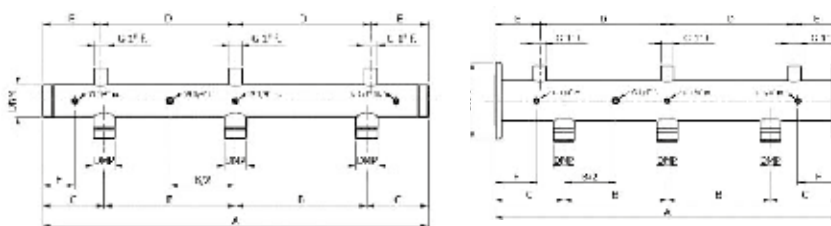

SUCTION MANIFOLD FOR 3 PUMPS

MODEL	CODE	DNM	DMP	DIMENSIONS MM				WEIGHT KG
				A	B	C	D	
T3A 200/100	PFMCOL610	2" M	1" M	900	300	150	65	2,10
T3A 200/125	PFMCOL611	2" M	1" 1/4 M	900	300	150	65	2,10
T3A 250/125	PFMCOL612	2" 1/2 M	1" 1/4 M	900	300	150	65	3,50
T3A 250/150	PFMCOL613	2" 1/2 M	1" 1/2 M	900	300	150	65	3,80
T3A 300/150	PFMCOL614	3" M	2" M	900	300	150	65	4,80
T3A 300/200	PFMCOL615	3" M	1" 1/2 M	900	300	150	65	4,85
T3A 300/200L	PFMCOL616	3" M	2" M	1060	360	170	65	4,98
T3A 400/200	PFMCOL617	DN100*	2" M	1120	360	200	95	12,77



* PN16 Flanges from pressed stainless steel.

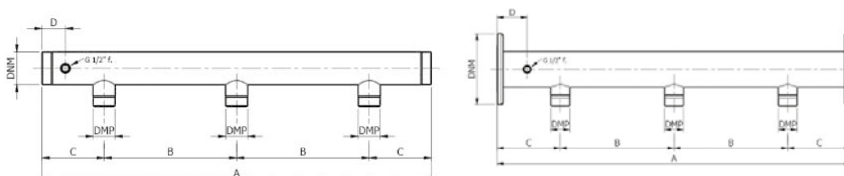

Made in Italy

STAINLESS STEEL CHECK VALVES



TECHNICAL FEATURES

Manufacturing proces:	Pressed stainless steel AISI 304 (or 316 on request)	Opening pressure:	Min. 0,025 bar / Max. 0,035 bar
Seal ring:	UNI ISO 228/1 female	Nominal working pressure:	16 bar
Welded joints:	Made with TIG method without without any additional material.	Working temperature and sealing:	-20°C - +110°C (with EPDM seal))

MODEL	SIZE	DN	PN	CODE	DIMENSIONS MM				SEAL RING	WEIGHT GR	PACKAGE
					A	B	C	D			
VRI	3/4"	20	16	PFMVAL001	30	67	44	18,3	FPM	129	8 pcs.
VRI	1"	25	16	PFMVAL002	35,8	83	53	23,4	FPM	191	8 pcs.
VRI	1" 1/4	32	16	PFMVAL003	45	97	62	31,4	FPM	281	6 pcs.
VRI	1" 1/2	40	16	PFMVAL004	50,8	115	78	36,8	FPM	388	6 pcs.
VRI	2"	50	16	PFMVAL005	63	120,5	89	42,9	FPM	704	4 pcs.
VRI	2" 1/2	65	16	PFMVAL006	80	142	113	58,7	FPM	1425	1 pcs.
VRI	3"	80	16	PFMVAL007	93	160	132	70,3	FPM	2085	1 pcs.

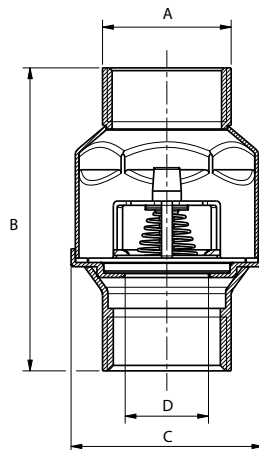

Made in Italy

BALL CHECK VALVE



TECHNICAL FEATURES

Threaded ends female	according to: UNI ISO 228/1	Applications:	Dense and loaded liquids.
Flanged ends	according to: UNI EN 192-2 PN 10/6	Nominal working pressure:	10 bar
Installation:	Vertical end horizontal	Working temperature:	-10°C - +70°C

MODEL	TYPE	MATERIAL	SIZE	DN	PN	CODE	DIMENSIONS MM		WEIGHT KG
							A	B	
VRPG114	Threaded	Cast iron	1" 1/4	32	10	PFMVRP001	140	80	2,1
VRPG112			1" 1/2	40	10	PFMVRP002	140	82	2,3
VRPG200			2"	50	10	PFMVRP003	180	90	3,1
VRPG212			2" 1/2	65	10	PFMVRP004	250	130	6,7
VRPI114		AISI 316	1" 1/4	32	16	PFMVRP005	175	99	1,1
VRPI112			1" 1/2	40	16	PFMVRP006	190	99	1,18
VRPI 200			2"	50	16	PFMVRP007	210	112	1,61

Note: Models with flanged connections available on request

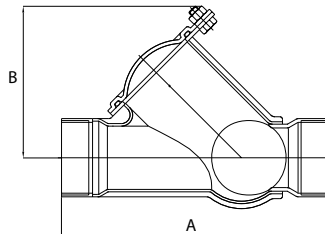

ALARM PANEL

DEVICE WITH ACOUSTIC AND VISUAL SIGNALLING FOR ALARM CONDITION

Equipped as standard with button for the exclusion of the siren.

Also available in the version with battery buffer.



MODEL	CODE	DIMENSIONS WxHxD
ALARM PANEL	PFIFS00006	205x220x140
ALARM PANEL WITH BATTERY BUFFER	PFIFS00007	275x220x140

QUALITY MARKS AND CERTIFICATIONS



Precisely Right.





TREVITECH s.r.l.

Via Tazio Nuvolari, 19

55012 Loc. Carraia - Capannori (Lu) - Italy

TEL. & FAX

T. +39 0583 490246

F. +39 0583 702006

E-MAIL

info@trevitech.it



www.trevitech.it



www.linkedin.com/company/trevitech-s-r-l

